

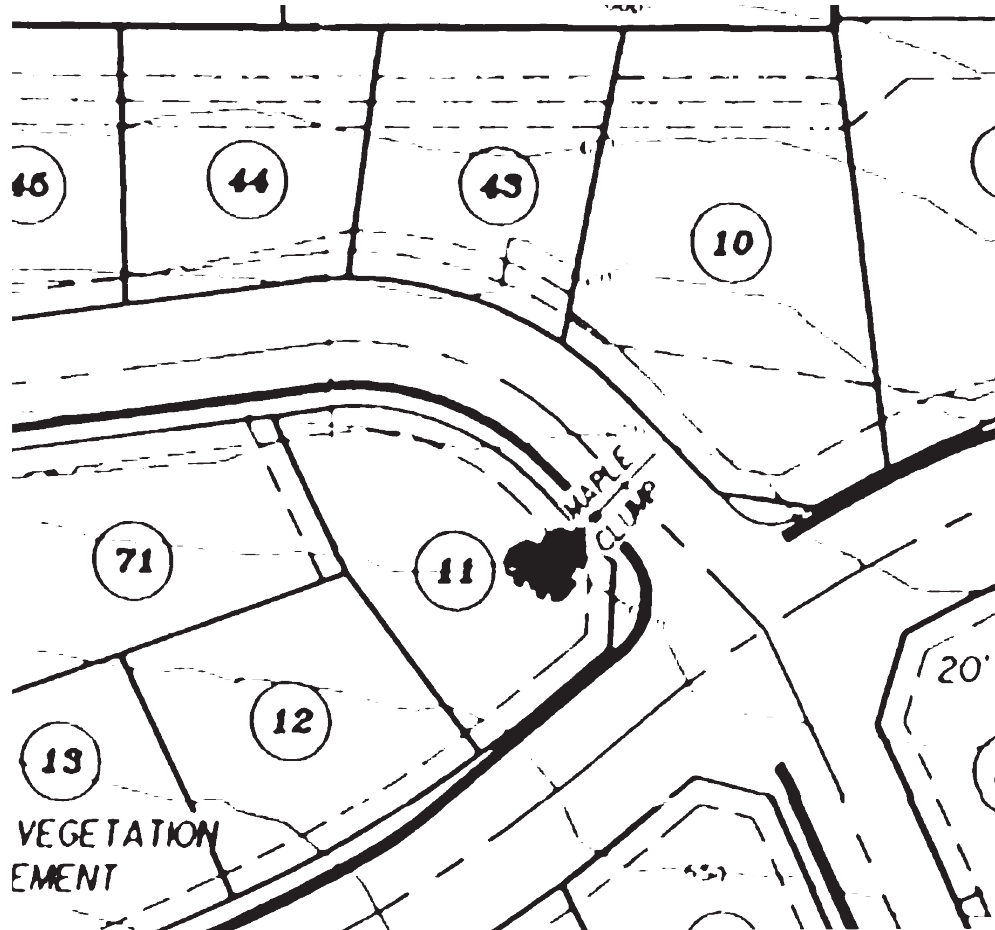

NORTH CAROLINA
DEPARTMENT OF TRANSPORTATION

SUBDIVISION ROADS

MINIMUM CONSTRUCTION STANDARDS



J. ERIC BOYETTE
SECRETARY OF TRANSPORTATION
TELEPHONE (919) 707-2800
jboyette@ncdot.gov

RONNIE L. KEETER, JR., PE
CHIEF ENGINEER
TELEPHONE (919) 707-2500
rkeeter@ncdot.gov

CHRIS PEOPLES, PE
DEPUTY CHIEF ENGINEER
TELEPHONE (919) 707-2500
cpeoples@ncdot.gov

JANUARY 2010
(Revised December 2020)

TABLE OF CONTENTS

	<u>PAGE #</u>
Division of Highways District Offices.....	2
Application Requirements	8
Subdivision Roads	10
A. Definitions	10
B. Addition of Subdivision Roads to the System	11
Utility Requirements	14
Minimum Design and Construction Criteria for Subdivision Roads	16
I. Construction Requirements.....	16
A. Drainage.....	16
B. Structures (Bridges, Culverts, Dams, and Retaining Walls).....	17
C. Curb and Gutter and Sidewalk.....	21
D. Wheelchair Ramps.....	22
E. Pavement Designs.....	22
F. Traffic Control	24
G. Guardrail	24
H. Road Intersections.....	24
I. Islands or Short Medians at Subdivision Entrances.....	25
J. Subdivision Name Markers.....	25
K. Minimum Design Criteria.....	26
1. Residential Local Subdivision Roads.....	26
2. Residential Collector Roads	27
3. Thoroughfare Plan Roads	28
4. Industrial Access or Commercial Complex Roads.....	28
NC General Statute §136-102.6.....	29
NC Administrative Code – Highway Obstructions Interfering with Traffic Maintenance.....	32
Petition for Road Addition.....	33
Verification of Compliance with Dept. of Environment & Natural Resources	35
Street and Driveway Access Permit Application	36
Standard Pipe Sizing Chart.....	38
FIGURE 1: Cross-Section: Shoulder Section.....	39
FIGURE 2: Cross-Section: Curb and Gutter Section	40
FIGURE 3: Recommended Road Connection w/Curb & Gutter to Shoulder Section.....	41
FIGURE 4: Recommended Road Connection with Shoulder Section	42
FIGURE 5: Recommended Road Connection with Curb and Gutter.....	43
FIGURE 6: Driveway Turnout Grades.....	44
FIGURE 7: Symmetrical Cul-De-Sac with Curb and Gutter	45
FIGURE 8: Symmetrical Cul-De-Sac with No Curb and Gutter	46
FIGURE 9: Detail Section View of Interior Island and Sign.....	47
Appendix A: Soil Type Base Course Special Provision --new in this revision--	48
Appendix B: Useful Weblinks	52
Appendix C-1: Updates to January 2000 Subdivision Manual.....	53
Appendix C-2: May 2016 Revisions to January 2010 Subdivision Manual.....	60
Appendix C-3: July 2020 Revisions to January 2010 Subdivision Manual	61
Appendix C-4: December 2020 Revisions to January 2010 Subdivision Manual.....	62

DIVISION OF HIGHWAYS

<u>DIVISION</u>	<u>DISTRICT OFFICES</u>	<u>TELEPHONE</u>
1	District 1- 1929 North Road Street Elizabeth City, N.C. 27909	(252) 331-4737 (252) 331-4739 FAX
	Counties- Camden, Currituck, Dare, Gates, Pasquotank, Perquimans	
	District 2- 230 NC 42 West Ahoskie, N.C. 27910	(252) 332-4021 (252) 332-3040 FAX
	Counties- Bertie, Hertford, Northampton	
	District 3- 19210 US Hwy 64 East Williamston, N.C. 27892	(252) 789-6150 (252) 789-0055 FAX
	Counties- Chowan, Hyde, Martin, Tyrrell, Washington	
2	District 1- 1701 West 5th Street Washington, N.C. 27889	(252) 623-5300 (252) 946-7433 FAX
	Counties- Beaufort, Greene, Pitt	
	District 2- 209 South Glenburnie Road New Bern, N.C. 28560	(252) 649-6500 (252) 514-4894 FAX
	Counties- Carteret, Craven, Jones, Lenoir, Pamlico	

<u>DIVISION</u>	<u>DISTRICT OFFICES</u>	<u>TELEPHONE</u>
3	District 1- 295-A Wilmington Hwy Jacksonville, N.C. 28540	(910) 467-0505 (910) 346-8030 FAX
	Counties- Onslow, Pender	
	District 2- 220 North Boulevard Clinton, N.C. 28328	(910) 682-5100 (910) 592-8209 FAX
	Counties- Duplin, Sampson	
	District 3- 300 Division Drive Wilmington, N.C. 28401	(910) 398-9100
	Counties- Brunswick, New Hanover	
4	District 1- 14194 Hwy 903 Halifax, N.C. 27839	(252) 583-4230 (252) 583-1608 FAX
	Counties- Edgecombe, Halifax	
	District 2- 3013 US 64-A Nashville, N.C. 27856	(252) 462-2580 (252) 459-2401 FAX
	Counties- Nash, Wilson	
	District 3- 2671 US 70 West Goldsboro, N.C. 27530	(919) 739-5300 (919) 731-2017 FAX
	Counties- Johnston, Wayne	
5	District 1- 4009 District Drive Raleigh, N.C. 27607	(919) 733-3213 (919) 715-5778 FAX
	Counties- Wake	

<u>DIVISION</u>	<u>DISTRICT OFFICES</u>	<u>TELEPHONE</u>
5	District 2- 815 Stadium Drive Durham, N.C. 27704	(919) 220-4750 (919) 560-3357 FAX
	Counties- Durham, Granville, Person	
	District 3- 321 Gillburg Road Henderson, N.C. 27537	(252) 598-5100 (252) 492-0123 FAX
	Counties- Franklin, Vance, Warren	
6	District 1- 872 NC 711 Hwy Lumberton, N.C. 28360	(910) 618-5546 (910) 618-5586 FAX
	Counties- Robeson	
	District 2- 600 Southern Ave Fayetteville, N.C. 28306-1524	(910) 639-0601 (910) 437-2529 FAX
	Counties- Cumberland, Harnett	
	District 3- 1194 Prison Camp Road Whiteville, N.C. 28472	(910) 642-3760 (910) 642-2984 FAX
	Counties- Bladen, Columbus	
7	District 1- 127 E. Crescent Square Drive Graham, N.C. 27253-0766	(336) 520-6060 (336) 570-6873 FAX
	Counties- Alamance, Orange	
	District 2- 1584 Yanceyville Street Greensboro, N.C. 27415-4996	(336) 487-0100 (336) 318-4573 FAX
	Counties- Guilford	

<u>DIVISION</u>	<u>DISTRICT OFFICES</u>	<u>TELEPHONE</u>
7	District 3- 1226 N Scales St Reidsville, N.C. 27320	(336) 634-5644 (336) 634-5656 FAX
	Counties- Caswell, Rockingham	
8	District 1- 300 DOT Drive Asheboro, N.C. 27204	(336) 318-4025 (336) 625-1012 FAX
	Counties- Chatham, Montgomery, Randolph	
	District 2- 902 N. Sandhills Blvd. Aberdeen, N.C. 28315	(910) 944-7621 (910) 944-5623 FAX
	Counties- Hoke, Lee, Moore, Richmond, Scotland	
9	District 1- 4770 South Main Street Salisbury, N.C. 28147	(704) 630-3200 (704) 761-2004 FAX
	Counties- Davidson, Rowan	
	District 2- 375 Silas Creek Parkway Winston-Salem, N.C. 27127	(336) 747-7900 (336) 703-6694 FAX
	Counties- Davie, Forsyth, Stokes	
10	District 1- 615 Concord Road (NC 73) Albemarle, N.C. 28001	(704) 983-4360 (704) 982-9659 FAX
	Counties- Cabarrus, Stanly	

<u>DIVISION</u>	<u>DISTRICT OFFICES</u>	<u>TELEPHONE</u>
10	District 2- 7605 District Drive Charlotte, N.C. 28213	(980) 523-0000 (704) 598-1758 FAX
	Counties- Mecklenburg	
	District 3- 130 S. Sutherland Ave. Monroe, N.C. 28112	(704) 218-5100 (704) 292-1800 FAX
	Counties- Anson, Union	
11	District 1- P.O. Box 558 Elkin, N.C. 28621	(336) 530-6000 (336) 835-1615 FAX
	Counties- Alleghany, Surry, Yadkin	
	District 2- P.O. Box 1460 Boone, N.C. 28607	(828) 268-6022 (828) 265-5414 FAX
	Counties- Avery, Caldwell, Watauga	
	District 3- P.O. Box 250 North Wilkesboro, N.C. 28659	(336) 903-7170 (336) 903-9218 FAX
	Counties- Ashe, Wilkes	
12	District 1- 1702 E. Main Street P.O. Box 47 Shelby, N.C. 28151-0047	(980) 552-4100 (704) 480-5438 FAX
	Counties- Cleveland, Gaston	
	District 2- 124 Prison Camp Rd. Statesville, N.C. 28625	(704) 380-6040 (704) 876-0602 FAX
	Counties- Alexander, Iredell	

<u>DIVISION</u>	<u>DISTRICT OFFICES</u>	<u>TELEPHONE</u>
12	District 3- 1031 E Gaston St. Lincolnton, N.C. 28092	(704) 748-2400 (704) 748-2403 FAX
	Counties – Catawba, Lincoln	
13	District 1- 3931 NC 226 S Marion, N.C. 28752	(828) 803-6100 (828) 652-8391 FAX
	Counties- Burke, McDowell, Mitchell, Rutherford	
	District 2- 11 Old Charlotte Highway Asheville, N.C. 28803	(828) 298-2741 (828) 299-3747 FAX
	Counties- Buncombe, Madison, Yancey	
14	District 1- 4142 Haywood Road Mills River, N.C. 28759	(828) 891-7911 (828) 891-5026 FAX
	Counties- Henderson, Polk, Transylvania	
	District 2- 178 Henry Bird Rd Whittier, N.C. 28789	(828) 497-7333 (828) 497-6095 FAX
	Counties- Haywood, Jackson, Swain	
	District 3- 191 Robbinsville Road Andrews, N.C. 28901	(828) 321-4105 (828) 321-3228 FAX
	Counties- Cherokee, Clay, Graham, Macon	

APPLICATION REQUIREMENTS

Any person or corporation desiring to construct a new subdivision road which is to be dedicated as public, must submit the following information to the District Engineer for proper evaluation in order to obtain a certificate of approval as required by North Carolina General Statute 136-102.6. (See Page 29 of this document for Statute.)

If the new subdivision road (to be dedicated as public or private) will connect to a state system road, a driveway permit/encroachment agreement authorizing construction on State right-of-way must be obtained from the Division of Highways before beginning any construction. Applications should be made to the District Engineer having jurisdiction in the area.

The appropriate District Engineer's Office can be determined from the listings beginning on Page 2 of this manual or the following link:

<https://apps.dot.state.nc.us/srmu/directory/public/EngDirHandler.ashx>.

1. Three complete site layouts with vicinity map, including any future expansions anticipated. Additional copies may be required by the District Engineer's Office.
2. Horizontal alignment indicating general curve data on site layout plan.
3. Vertical alignment indicated by percent grade, P.I. station, vertical curve length, and k-value, on site layout plan. Existing ground profile along centerline should also be included.
4. Typical section indicating the pavement design and width of pavement. All slopes shown in accordance with drawings on Pages 40 and 41 of this manual.
5. Submission of hydraulics plans and drainage calculations are required. A copy of U.S. Geodetic Survey or other contour mapping showing drainage areas is also required. (NOTE: A sample standard pipe sizing chart is shown on Page 38 or any generally accepted industry standard containing the same information as shown in the example may be used.)
6. Two copies of the recorded plat are to be furnished to the District Engineer after certification or upon application for State Maintenance.
7. On new subdivision roads, lot lines should not extend into the right-of-way. *See North Carolina Transportation and Highway Laws*, chapter 136, article 7, section 136-102.6 for additional information on right-of-way width and lot lines. (See Page 29 of this document for statute).
8. When property is subdivided along existing state maintained roads, the lot lines may extend into the right of way subject to the property owners discretion.
9. A minimum of four separate site plans for driveway permits will be required prior to construction within NCDOT Right of Way. (See Pages 36 and 37 for permit).
10. Copy of erosion control plans and permit, approved by Department of Environment and Natural Resources or local government, may be required by the District Engineer. (See Page 35.)

11. Encroachment agreements (utility & non-utility) are required prior to addition of road to State System. (For agreement forms, please contact District Engineer.)

SUBDIVISION ROADS

A subdivision road is one that serves a parcel or tract of land that is subdivided into two or more lots, building sites or other divisions for sale or building development for residential purposes where such subdivisions include a new road or change in an existing road.

Subdivision roads shall be designated public or private. Public designations shall be designed and constructed to minimum construction standards of the North Carolina Department of Transportation as required under North Carolina General Statute 136-102.6. and are eligible to be added to the State system of roads. (See Page 29 of this document). Private roads are not eligible to be added to the state system of roads and need not meet minimum construction requirements.

Definitions

The following definitions shall apply in this manual:

1. Residential Local Subdivision Road - Either cul-de-sacs, loop roads, roads that do not connect thoroughfares or serve major traffic generators.
 - A. Dead End Roads - These are roads less than 2,500 feet in length, open at one end only without special provisions for turning around and have no collector characteristics.
 - B. Short Connecting Roads - These roads are normally one block long or extend on a block-by-block basis and have no collector characteristics.
 - C. Loop Roads - A road that has its beginning and ending points on the same route. It is less than one mile in length and has no collector characteristics.
 - D. Other Roads - These roads do not connect thoroughfares or serve major traffic generators and do not have "collector" characteristics.
 - E. Cul-De-Sacs - These are very short roads, open at one end only, with a special provision for turning around. They have a "bulb" end design with a specific turning radii and a limited number of lots.

2. Residential Collector Subdivision Road - A road which serves as the connecting street between local residential roads and the thoroughfare system.
 - A. Dead End Roads - These roads are more than 2,500 feet in length, open at one end only without special provisions for turning around, and have collector characteristics.
 - B. Connecting Roads - The roads which serve as the connecting road system between other roads within the subdivision and the thoroughfare system.
 - C. Loop Roads - A road that has its beginning and ending points on the same route. It is more than one mile in length and has collector characteristics.

- D. Other Roads - These are other roads having a "collector" type function in the thoroughfare system.
- E. Subdivision Access Road - This is a road built through vacant property to provide access to the property being developed. This road would not have lots platted along it.

Requirements for Addition of Subdivision Roads to the System:

1. The minimum construction standards and other requirements in this manual must be a part of the proposal to be reviewed for approval prior to development in order for a plat to be recorded by the County Register of Deeds.
2. A Petition for Addition (DOT Form SR-1) is required from the developer and/or property owners. (See Pages 33 and 34 of this document.)
3. Developers or property owners must dedicate right-of-way, as indicated in the minimum design and construction criteria section of this manual, free of charge and clear of all encumbrances, including structural stormwater control (SSC) devices. (See Page 16 of this document.)
4. Existing utilities may remain within the right-of-way of any subdivision road added to the Secondary Road System provided the location of same meets Division of Highways' approval and the utility owner executes an encroachment agreement on forms furnished by the Division of Highways. Should utility adjustments or relocation to conform to Division of Highways' requirements be required, (See *Policy and Procedures for Accommodating Utility on Highway Rights of Way*; <https://connect.ncdot.gov/municipalities/Utilities/Pages/UtilitiesManuals.aspx>) they shall be made at no expense to the Division of Highways. As per General Statute 136-102.6, "Utilities are defined as electric power, telephone, television, telegraph, water, sewage, gas, oil, petroleum products, steam, chemicals, drainage, irrigation and similar lines."

G. S. 136-102.6 dictates further that "The right of any utility placed or located on a proposed or existing subdivision public road right-of-way shall be subordinate to the road right-of-way, and the utility shall be subject to regulation by the Board of Transportation". NOTE: The developer and/or owners will be required to submit encroachment agreements for all utilities within a subdivision as dictated by G. S. 136-102.6. (See Page 29 of this document for Statute).
5. At least 20 percent of the lots bordering the road must be individually owned.
6. There must be at least two occupied residences for each one-tenth of a mile. A minimum of four occupied homes is required for the addition of roads less than two-tenths of a mile in length. If four occupied homes are not served, it will be treated as a private drive. An exception may be made if the cul-de-sac is fully developed, serves at least four platted lots, and has four occupied homes that abut the road. A minimum of two homes must have primary access to the cul-de-sacs.

7. Subdivision Access Roads must provide ingress and egress for at least five occupied residences for roads less than one mile in length and an average of five occupied residences per mile for roads over one mile in length.
8. The number of platted lots on each road will be reviewed to ensure that the minimum occupied housing requirements in this manual are served.
9. Connecting roads with less than the required occupied homes for the length involved may be reviewed as to traffic usage for addition purposes. Traffic usage equivalent to the traffic that would be generated by the correct number of occupied homes will be acceptable.
10. Any subdivision road with a right-of-way dedicated, recorded, or that has preliminary approval from a county planning board dated after September 30, 1975, will not be added to the State System unless the road is built to the minimum construction standards of the Division of Highways for subdivision roads.
11. Erosion and Sedimentation - All subdivision roads shall have an acceptable permanent vegetative cover established and other acceptable permanent erosion control measures installed in accordance with Division of Highways' specifications, prior to addition to the State maintained system.
12. Subdivision roads shall meet the minimum design and construction criteria contained herein prior to addition to the State system and shall be in an acceptable state of maintenance prior to addition to the State maintained road system.
13. All pipe culverts, storm sewers and appurtenances shall be free of all debris and silt build-up and shall be structurally and hydraulically sound, and functioning in a normal manner. All drainage structures shall be of sufficient length to accommodate appropriate roadway side slopes, as defined in the minimum construction standards in this manual, with standard height headwalls. Extended height headwalls intended to reduce drainage structure length or to reduce right of way requirements are not acceptable. All drainage ditches shall be of such a width and depth and with such a slope as to carry the anticipated discharges. Paved ditches or Rip Rap shall be required where necessary.
14. Where extenuating circumstances exist, the Division Engineer has the authority to allow deviations from this manual which are reasonable, and limited only to safety, environmental and maintenance factors. No deviation will be allowed from the typical section requirements except by written approval from the Chief Engineer-Operations.
15. Within a Municipal Extra Territorial Jurisdiction or within Counties having local ordinances affecting subdivisions, the more restrictive ordinance shall apply if maintenance responsibilities by the NCDOT are not increased beyond normal maintenance by applying the construction standards of this document.
16. Designs using walkable community concepts shall be reviewed by the Chief Engineer - Operations. Traditional Neighborhood Development Street Design Guidelines (walkable community) can be found at: <https://connect.ncdot.gov/projects/Roadway/RoadwayDesignAdministrativeDocuments/Traditional%20Neighborhood%20Development%20Manual.pdf>
17. For the Policy on Roadway Bridges and Dams, see Page 17.

18. Roads being considered for addition must be clear of highway obstructions as defined in NCAC 2E.0404. (See Page 32.)
19. The Division of Highways will consider the addition of streets that serve developments with large lots or parcels that are of the size that the occupied housing requirement of two homes per tenth of a mile cannot be met. The number of occupied homes needed shall be a judgment factor based upon the length and the number of lots or parcels involved. The minimum requirement shall be four occupied homes.

UTILITY REQUIREMENTS

1. Poles and other above-ground utilities which are to remain inside the right-of-way under encroachment agreement shall be located at or as near as practical to the right-of-way line. As a minimum, above-ground utilities shall be located outside the clear roadside area for the highway section involved.

Where there are curbed sections, above-ground utilities should be located as far as practical behind sidewalks. There is no single minimum dimension for setback of poles, fire hydrants, etc., behind curbs; however, where there are curbed sections and no sidewalks, 6' will be used as a design safety concept guide.

2. Minimum Depth of Cover for Pipe Lines and Other Utilities

a.	Longitudinal pipe lines and electric power primary	3'
b.	Longitudinal electric power secondary, and trenched communication lines	2'
c.	Crossings under roadways	3'
d.	Crossings under ditches	2'
e.	Plowed-in communication lines except fiber optic.....	18"
f.	Plowed-in fiber optic.....	24"

3. For residential local subdivision streets, underground utilities may cross under or run longitudinally under the pavement provided future utility stub-outs are installed prior to paving. For all other streets and highways, underground utilities may cross under but not run longitudinally under the pavement except in unusual situations approved by the Division Engineer.

4. Acceptable Materials for Pipeline with Utilities Within the Rights of Way - Materials not listed shall be referred to the Field Operations Support - Utilities Section.

- a. Smooth Wall Steel Pipe meeting API 5L Grade B Specifications
- b. Spiral Welded Steel Pipe meeting ASTM Specification A-211
- c. Circular Black Steel Pipe meeting ASTM Specification A-120 or A-589
- d. Galvanized Steel Pipe Meeting ASTM A-120 Specifications
- e. Ductile Iron Pipe – class 50 Min. Strength
- f. Concrete Sewer Pipe – Plain and Reinforced Pipe meeting Department of Transportation Standard with Rubber Gasket Joints
- g. Reinforced Concrete Pressure Pipe, Steel Cylinder Type for Water and other Liquids meeting AWWA Specifications C-300, C-301, and C-303
- h. ABS (Acrylonitrile – Butadiene – Styrene) Composite Sewer Pipe shall meet ASTM D-2680 Specifications for Pipe sizes 8” thru 15” and ASTM D-2751 for pipe sizes 4” and 6” for Laterals. ABS Sewer Pipe shall be used for Domestic Sewage only; also, P.V.C. Truss Pipe meeting ASTM D-2321 which has to be specified by registered Professional Engineer.
- i. P.V.C. (Polyvinyl Chloride) Water Pipe (pressure only) – SDR 14 (C-900), SDR 18 (C-900) and SDR 21.
- j. P.V.C. (Polyvinyl Chloride) Sewer Pipe (Force Main) SDR 14 (C-900), SDR 18 (C-900) and SDR 21.

- k. P.V.C. (Polyvinyl Chloride) pipe (Gravity Sewer) SDR 14 (C-900), SDR 18 (C-900), SDR 21, SDR 26, SDR 35, ASTM F 794, ASTM F 949 (A-2000) and Schedule 40 and 80.
 - l. V.C. (Vitrified Clay) Sewer Pipe, Extra Strength meeting ASTM Specifications C-700 with Factory Fabricated Joints meeting ASTM Specifications C-425.
 - m. P.E. (Polyethylene) Plastic Pipe – SDR 7 meeting ASTM Specifications D-2239 and Plastic Tubing – SDR 9 meeting ASTM Specification D-2737 for sizes ¾” thru 2” only.
 - n. Polyethylene Plastic Pipe (High Molecular Weight) and (Medium Molecular Weight) SDR 11 meeting Plastic Pipe Institute Material Designation PE 3408 and PE 2406 in sizes up to 6.625” O.D. for gas with maximum operating pressure of 60 PSIG.
 - o. Type K Copper Pipe meeting ASTM Specification B-88 for sizes ¾” thru 2”.
5. Any utility to be installed within the right-of-way of a state maintained road will require an encroachment agreement with the North Carolina Board of Transportation in accordance with their publication entitled *Policies and Procedures for Accommodating Utilities on Highway Rights of Way*.
(<https://connect.ncdot.gov/municipalities/Utilities/Pages/UtilitiesManuals.aspx>)
6. All non-ferrous pipelines shall be installed with a locating tape.
7. All utility structures (i.e. vaults, manholes, and boxes) shall be load rated for the appropriate dead load plus an HL-93 live load. Such structures shall be designed and certified by a licensed professional engineer.
8. Electrical power and communication facilities should conform to the currently applicable National Electrical Safety Code except vertical clearances shall be no less than 18 feet in any case.

MINIMUM DESIGN AND CONSTRUCTION CRITERIA FOR SUBDIVISION ROADS

CONSTRUCTION REQUIREMENTS

A. DRAINAGE

The Division of Highways shall review all drainage prior to acceptance of any facility to the State System. Drainage, utility, or public easements, are not considered a portion of the highway facility.

All storm drainage shall be adequate so that the road and rights of way may be maintained without excessive cost, and not cause flooding on private property from storm runoff of the design frequency. Permanent drainage easements may be established by the designer; however, the NCDOT does not accept maintenance responsibility for the easement outside of the roadway right-of-way. The minimum design frequency shall be as follows but may be increased at the recommendation of the State Hydraulics Engineer.

1. Storm sewer collector - 10 years
2. Cross drainage for Secondary Routes - 25 years
3. Cross drainage on primary and N.C. routes will be 50 years.
4. Minimum Cross Pipe diameter is 18", Minimum Driveway Pipes diameter is 15".
5. All drainage shall be consistent with criteria found in *NCDOT - Guidelines for Drainage Studies and Hydraulic Design*.
<https://connect.ncdot.gov/resources/hydro/Pages/Guidelines-Drainage-Studies.aspx>

Note: Use of hydraulic design forms found in *Guidelines for Drainage Studies and Hydraulic Design* will expedite the design review process.

In areas where ditch grades or quantities of flow deem it impracticable to establish and maintain vegetation, an erosive resistant lining such as paving, matting or rip rap may be required.

Subsurface drainage shall be adequate to maintain a stable subgrade.

When road crossings are within areas designated as flood hazard areas under the Federal Flood Insurance Program, the design must be approved by the responsible local governing agency for its consistency with local flood zoning ordinances. Structural stormwater controls shall be located outside the right-of-way.

Structural control devices shall be shown on plans. The DOT assumes no responsibility for maintenance nor liability of the stormwater control devices (see Page 17 for Structural Stormwater Controls).

Project Materials shall meet NCDOT Standards. Types of approved material shall be consistent with materials listed in "*Guidelines for Drainage Studies and Hydraulic Design*".

Structural Stormwater Controls

The Department of Environment and Natural Resources (DENR) or the local governing agency may require the design and installation of structural stormwater controls (SSC's) as part of a stormwater management plan for the subdivision. Alternatively, the developer/land-owner may voluntarily install SSC's. All SSC's shall be constructed and maintained in accordance with applicable laws, ordinances, regulations, rules and directives of governmental authorities having jurisdiction over stormwater management activities.

All SSC's, and any associated drainage easements, shall be located outside of the NCDOT right-of-way. The NCDOT assumes no responsibility for operation, maintenance, or liability of the SSC's.

A North Carolina licensed professional engineer shall sign and seal a certification on the plan that all SSC's meet the stormwater management requirements of the governmental authorities having jurisdiction over stormwater management activities. In addition, the Engineer must provide a certification of completion and verify that all SSC's are constructed in accordance with applicable regulations.

Prior to addition of the subdivision road to the State system, the property owner must execute an operation and maintenance agreement for the SSC's that shall be binding on all subsequent owners of the property, portions of the property, and lots or parcels served by the SSC's. The operation and maintenance agreement shall ensure that the SSC's are operated and maintained so as to preserve and continue their function in controlling stormwater at the degree and amount of function for which the SSC's were designed; shall require the owner (or homeowners' association or similar entity) to maintain, repair and, if necessary, reconstruct the SSC's; and shall state the terms, conditions, and schedule of maintenance for the SSC's. For SSC's that are or are to be owned by a homeowners' association or similar entity, the operation and maintenance agreement shall acknowledge that the association shall continuously operate and maintain SSC's **at no cost to Division of Highways**.

All SSC's and associated access/maintenance easement(s) shall be depicted on a final subdivision plat which is recorded with the county Register of Deeds. The operation and maintenance agreement shall be referenced on the final plat and shall be recorded with the county Register of Deeds upon final plat approval.

B. STRUCTURES (BRIDGES, CULVERTS, DAMS AND RETAINING WALLS)

Bridges

Minimum criteria for bridges to be built by private interest for future acceptance by the Division of Highways.

1. Bridges which are to span streams shall be designed for hydraulic requirements in accordance with Division of Highways criteria, and plans shall be submitted to the Hydraulics Unit for review and approval. Bridge submittals shall include alternate structures considered and reasonable justification for selection of bridge structure and length. Generally, avoidance of individual environmental permits would not

be considered reasonable justification for use of excessive hydraulic structures or bridge lengths. Deck drains discharging into open water should be avoided.

Rip Rap will be required as recommended by the Hydraulics Unit.

2. Bridges shall be designed for minimum live load of HL-93 as specified in the *AASHTO LRFD Bridge Design Specifications*, and the current edition of the Structure Design Unit *Design Manual*.

Bridges shall be rated in accordance with the *AASHTO Manual for Bridge Evaluation* and the current edition of the Structure Design Unit *Design Manual*. All design load ratings and legal load ratings shall be greater than 1.0.

Plans shall be submitted for review and approval by the Structure Design Unit.

3. Bridge deck widths and clearances shall be in accordance with the North Carolina Department of Transportation "Bridge Policy." For bridges with curb and gutter approaches, the clear bridge width shall be the same as the face to face approach width except where bikeways or sidewalks are carried across the structure. Curb and gutter will be transitioned out in 50 feet to line up the face of curb and bridge rail. For shoulder section roadways, the bridge width should be a minimum of 24'.
4. The following materials are acceptable for bridge construction:
 - a. For substructures - reinforced concrete, structural steel, pre-stressed concrete, or steel piles or combination of these materials.
 - b. For superstructures - pre-stressed concrete, reinforced concrete deck slab, or structural steel I-beams with reinforced concrete deck.
 - c. The type and design of bridge rails shall be as approved by the Structure Design Unit of the Division of Highways.
5. Guardrail shall be installed at the bridge approaches in accordance with *North Carolina Roadway Standard Drawings*.
6. All material and workmanship used in construction of the structure shall be in accordance with *North Carolina Standard Specifications for Roads and Structures* and *North Carolina Roadway Standard Drawings*.

Culverts

A culvert is a conduit that conveys flow through the embankment. Culvert shapes may include circular, rectangular, elliptical, pipe-arch, and arches. They range in size from large multiple barrel culverts to single 18” pipes.

1. The minimum pipe size for cross pipe drainage is 18”.
2. Culverts in a riverine environment must be designed for hydraulic conveyance needs in accordance with Division of Highways criteria. Use of oversized structures to circumvent environmental permit responsibility creates excessive cost for Division of Highways in perpetual inspection/maintenance and future replacement needs. Therefore, drainage structures that greatly exceed hydraulic requirements for highway purposes will not be accepted for future maintenance unless to refuse would create “considerable and real hardship” for the applicant. Environmental permitting under a Nationwide Permit to avoid Individual Permit does not constitute “considerable or real hardships.” An example of a “considerable and real hardship” would be the presence of “Threatened or Endangered Species” as determined by USFW. Specific locations for use of oversized structures should be coordinated with Division of Highways personnel prior to design and construction of the subdivision.
3. Headwalls are generally used on the inlet end of culverts 36-inch and larger. Maximum height of headwalls shall be one foot above pipe structure. Neither Mechanically Stabilized Earth (MSE) nor Modular Block walls are considered appropriate for culvert headwall applications.
4. Allowable headwater elevation is established based on designers’ evaluation of natural flow depths, potential flooding of upstream structures and land use, as well as proposed roadway elevations. Culverts should be analyzed for both inlet control and outlet control conditions. Where inlet control governs conveyance, headwater depth is also limited to the ratio of headwater depth divided by pipe diameter (rise for arches) equal to 1.2 or 1.5 feet below the shoulder point (at the sag in vertical alignment), whichever results in the lower headwater depth. Where outlet control governs conveyance, the allowable Head (H) should be limited to 2 feet maximum and provide 1.5 feet freeboard below the shoulder point.
5. The slope of a culvert should approximate that of the natural channel. The invert elevation should be slightly below the natural bed ranging from 0.1 +/- feet for small pipes to 1.0 +/- feet for large structures. The normal burial depth for pipes less than or equal to 48” is 20% of the diameter. Pipes larger than 48” are buried 1.0 foot. Where fish passage is a primary consideration, the invert should be a minimum of 1.0 feet below the natural bed. Baffles may be placed in the invert to promote retention of bed material and formation of a low flow channel. If non-erodible rock is found along the entire culvert length at a depth less than 5 feet, a bottomless structure may be constructed on footings which can minimize disturbance of the natural channel bed. NCDOT’s Geotechnical Unit must review subsurface investigation reports provided by applicant to confirm acceptable foundation material prior to final selection of a “bottomless” culvert alternate.

6. Culverts must be long enough to accommodate the proposed typical roadway section and a 2:1 fill slope, or flatter, from shoulder point to the crown of structure or roof slab (not headwall).
7. Culverts must be designed to provide for minimum HL-93 live load.
8. Culverts shall be rated in accordance with the *AASHTO Manual for Bridge Evaluation* and the current edition of the Structure Design Unit *Design Manual*. All design load ratings and legal load ratings shall be greater than 1.0.

Roadway Dams

1. In those cases, where no other feasible alternatives exist, the utilization of a dam for a roadway may be considered.
2. Where it is determined that a dam will be utilized as a roadway, the following criteria must be met:
 - a. When applicable, the dam must have certification from the N. C. Department of Natural Resources and Community Development pursuant to the "Dam Safety Law of 1967," (as amended by the General Assembly of 1977).
 - b. All pertinent data regarding the design of the embankment as an impoundment structure must be presented to the Division of Highways for review.
 - c. The top cross section dimension must be the roadway width required (from shoulder point to shoulder point) for the facility plus a minimum of 4 feet.
 - d. Guardrail will be provided on the impoundment side of the roadway and installed in accordance with *North Carolina Roadway Standard Drawings*. For safety the District Engineer may require guardrail on both sides of the roadway.
 - e. Spillway will be designed to provide 2 feet of freeboard at the shoulder for an estimated 50-year design frequency outflow as a minimum.
 - f. A means of draining the lake completely will be provided.
3. Design acceptance or approval by the Division of Highways is limited to the use of the dam as a roadway and is in no way intended as approval of the embankment as an impoundment structure.
4. Responsibility incurred by the Division of Highways when a section of roadway crossing a dam is accepted as a part of the state maintenance system is limited to maintenance of the roadway for highway purposes from shoulder point to shoulder point only. Responsibility for the impoundment, any damage that may result there from, and maintenance of the dam or appurtenances as may be required to preserve its integrity as a water impoundment structure, shall remain with the owner of the impoundment. Any such maintenance work will be subject to the provisions of G.S. 136-93.
5. Impoundment of water on highway right-of-way may be allowed under the following criteria:

- a. The impoundment does not adversely affect the right-of-way for highway purpose.
 - b. Adjustment, as required, flattening slopes, installing rip rap, and any others, shall be the responsibility of the developer.
6. Structures under, over and/or on Dams shall be designed and plans prepared under the supervision of a Licensed Professional Engineer.

Retaining Walls

Rights of way and slope maintenance easements sufficient in width to accommodate appropriate roadway side slopes in accordance with the minimum construction standards in this manual shall be transferred to the Division of Highways. Retaining walls are roadside obstacles and will only be allowed where no other feasible alternatives exist. In the case an exception is warranted and approved by the Division Engineer, retaining wall design must be reviewed by Geotechnical Engineering Unit.

C. CURB AND GUTTER AND SIDEWALK

All curb and gutter and sidewalk sections shall meet Division of Highways standards.

1. The standard 2'-6" concrete curb and gutter is the preferred type to be used. Any other types of curb and gutter shall be subject to the approval of the District Engineer.
2. Curb inlet spacing and storm system design shall be consistent with criteria found in *NCDOT - Guidelines for Drainage Studies and Hydraulic Design*.
<https://connect.ncdot.gov/resources/hydro/Pages/Guidelines-Drainage-Studies.aspx>
3. NCDOT will allow sidewalks by encroachment and will not accept responsibility for maintenance. Maintenance responsibility of sidewalks shall be noted on plat. All sidewalks shall meet requirements of the "Americans With Disabilities Act".
4. Catch basins shall be NCDOT standard frame, grates and hood. Where other than standard 2' 6" curb is used, an approved transition section before and after the standard frames, grate and hood will be required.
5. Catch basins should be avoided in curb radii.
6. Allowable gutter spread is limited to gutter width plus ½ travel lane for outside lane. Median gutter spread is limited to gutter width plus 2 feet.
7. Standard minimum depth boxes shall be used when practical to eliminate excessively deep pipe drainage system.
8. Pipe drainage system is to be located beneath curb. Longitudinal runs beneath roadway should be avoided. Pipes connecting catch basins to trunk lines on the

opposite side of the roadway shall cross as near to perpendicular to the roadway as feasible.

D. WHEEL CHAIR RAMPS

In accordance with General Statute 136-44.14, all street curbs in North Carolina being constructed or reconstructed for maintenance procedures, traffic operations, repairs, correction of utilities or altered for any reason after September 1, 1973, shall provide wheel chair ramps for the physically handicapped at all intersections where curb and gutter is provided and at other major points of pedestrian flow.

Wheel chair ramps and depressed curbs shall be constructed in accordance with details contained in the Department of Transportation, Division of Highways' publication entitled, *Guidelines, Curb Cuts and Ramps for Handicapped Persons*. (North Carolina Roadway Standard Drawings No. 848.05 and 848.06)

E. PAVEMENT DESIGNS

Shown below are minimum thicknesses of base and surface course to be used. Design guidelines should be chosen from Group I or Group II depending on subgrade soil type. The District Engineer may require a subgrade soil test to determine the soil classification type and heavier pavement designs than the minimum designs depending on route classification (local/collector) and traffic loading impacts of planned subdivision phases. A prime coat may be required on ABC.

NOTE: For additional information on the design and construction of Concrete Pavement for Local Roads and Streets, see web link below:

<https://connect.ncdot.gov/resources/Asset-Management/Pages/subdivisions.aspx>

The following documents can be found at this link on the NCDOT Connect website:

Concrete Pavement for Local Roads & Streets

Specifications - Concrete Pavement for Local Roads & Streets

Design Guidance - Concrete Pavement for Local Roads & Streets

Detail Drawings - Concrete Pavement for Local Roads & Streets

Standard Notes - Concrete Pavement for Local Roads & Streets

GROUP I

<u>Good to Excellent</u> <u>Subgrade Soil Types</u>	<u>Base Course</u>	<u>Pavement Surface</u>
A-1-a, A-1-b, A-3	7" STBC, Type A or C.....	2" S9.5B
A-2-4, A-2-5, A-2-6,	9" STBC, Type A or C.....	1 ½" S9.5B
A-2-7	8" ABC or STBC, Type B.....	AST
	6" ABC or STBC, Type B.....	1 ½" S9.5B
	3" B25.0C.....	1 ½" S9.5B
	4" ABC.....	5" Jointed Concrete

NOTE: For additional information on the design and construction of Concrete Pavement for Local Roads and Streets, see web link below:

<https://connect.ncdot.gov/resources/Asset-Management/Pages/subdivisions.aspx>

GROUP II

<u>Poor to Fair</u> <u>Subgrade Soil Types</u>	<u>Base Course</u>	<u>Pavement Surface</u>
A-44, A-5, A-6,	9" STBC, Type A or C.....	2" S9.5B (1 layer)
A-7-5, A-7-6	8" ABC or STBC, Type B.....	1 ½" S9.5B
	10" ABC or STBC, Type B.....	AST
	4" B25.0C.....	1 ½" S9.5B
	4" ABC.....	6" Jointed Concrete

NOTE: For additional information on the design and construction of Concrete Pavement for Local Roads and Streets, see web link below:

<https://connect.ncdot.gov/resources/Asset-Management/Pages/subdivisions.aspx>

Decorative pavers may be permitted by encroachment. However, maintenance of decorative pavers will not be performed by NCDOT.

NOTE:

Subgrade No base course shall be placed on muck, pipe clay, organic matter or other unsuitable material.

<u>ABC</u>	Aggregate Base Course
<u>STBC***</u>	Soil Type Base Course
<u>AST</u>	Asphalt Surface Treatment – Mix design to be approved by District Engineer
<u>S9.5B</u>	Asphalt Concrete Surface Course, Type S9.5B
<u>B25.0C</u>	Asphalt Concrete Base Course, Type B25.0C

***See Soil Type Base Course Special Provision in Appendix A

Other base courses such as various cement-treated materials may be used in lieu of those shown above. These materials shall be of sufficient thickness to provide equivalent strength. However, any design other than those shown above must also be approved prior to use by the District Engineer

All materials shall meet the requirements set forth in the latest edition of the *North Carolina Standard Specifications for Roads and Structures*.

F. TRAFFIC CONTROL

The construction of all subdivision road intersections including those with existing state maintained roadways shall be constructed using traffic control standards as designated in the “*Manuals on Uniform Traffic Control Devices*”, “*North Carolina Supplement to the Manual on Uniform Traffic Control Devices*”, and the “*North Carolina Highway Design Branch Roadway Standard Drawings*,” prior to formal addition to the system. See G.S. 136-30.

G. GUARDRAIL

Guardrail may be required at locations meeting guardrail warrants in accordance with NCDOT Design Standards.

Warrant for guardrail may also warrant shoulder berm gutter.

H. ROAD INTERSECTIONS (See Figures 3 & 4 on Pages 41 & 42.)

1. The most desirable intersections are those with angles of 75 to 90 degrees. Intersections with angles from 60 to 75 degrees are acceptable where no other alternatives exist.
2. Minimum sight triangle for stop condition when connecting new local residential roads or residential collector roads to existing state maintained roads is 70 feet along the existing road right of way and 10 feet along the new road right of way.
3. All internal intersections shall have minimum 30’ radii. Radii less than 30’ must be approved by the District Engineer.

4. Non-standard design configurations will be reviewed on a case by case basis and must have approval of the District Engineer prior to formal addition to the state system.

I. ISLANDS OR SHORT MEDIANS AT SUBDIVISION ENTRANCES

The Division of Highways will review requests for the allowance of islands or short medians desired for aesthetics on State Highway System Secondary Roads at the entrance to a subdivision. Approval will be with the following understanding:

1. The District Engineer may allow the island or median sections after review on an individual basis and noted on plans (or encroachment agreement). This shall include all plantings.
2. The Division of Highways will not maintain the island or the median section.
3. The island or the median section will be removed if not properly maintained by someone involved with the subdivision, i.e. developer, homeowners, etc.
4. The minimum lane width at the entrances, excluding curb and gutter, will be 14 feet. Maximum width of island shall be 20 feet. (See Page 47 for detail).

J. SUBDIVISION NAME MARKERS

The Division of Highways will review requests to erect subdivision name markers on an individual basis. The name markers may be allowed to be located within the State Highway System Secondary Road rights-of-way at the beginning of a subdivision road provided the location of such is outside the line of sight and the normal maintenance limits. The name markers may be approved only at locations which will not sacrifice safety to the general traveling public. Approval to erect subdivision name markers will be with the following understanding:

1. All costs will be the responsibility of the requester.
2. The Division of Highways will not maintain the marker or the area around the marker.
3. The markers may be removed if not properly maintained.
4. The Division Engineer may allow the subdivision name markers on secondary road rights-of-way after review on an individual basis.
5. If non-breakaway design, a 30-foot set back from the edge of pavement of the existing state maintained road is required.

(See Page 47 for typical dimensions associated with marker installation.)

K. MINIMUM DESIGN CRITERIA

1. Residential Local Subdivision Roads include:

- a. Cul-De-Sacs
- b. Dead End Roads - Less than 2500 feet in length
- c. Short connecting Roads - One block long or that extend on a block by block basis
- d. Loop Roads - Less than 1 mile in length
- e. Other roads that do not connect thoroughfares or serve major traffic. These roads do not have "collector" characteristics.

<u>TERRAIN CLASSIFICATION</u>	<u>LEVEL</u>	<u>ROLLING</u>	<u>MOUNTAINOUS</u>
Terrain Classification Definition			
<u>Level</u> - Natural slope range of 0% to 8%			
<u>Rolling</u> - Natural slope range of 8.1% to 15%			
<u>Mountainous</u> - Natural slope over 15%			
Right of Way Width			
Curb and Gutter Section	40'	40'	40'
Shoulder Section	50'	50'	45'
Pavement Width			
Curb and Gutter Section * (See page 28)	*26' F-F	*26' F-F	*26' F-F
Shoulder Section	18'	18'	18'
F-F refers to face to face of standard curb and gutter section. Other types will be reviewed by the District Engineer with the F-F limits applicable			
Minimum Shoulder Width			
Shoulder Section	6'	4' to 6'	4' to 6'
Shoulder width between 4' to 6' shall be approved by the District Engineer considering adjacent land characteristics			
Maximum Cut and Fill Slopes	2:1	2:1	1 1/2:1
Design Speed	30 mph	25 mph	20 mph
Minimum Sight Distance on Vertical Curves	200'	150'	110'
Minimum Centerline Radius	230'	150'	90'
Minimum Superelevation Rate for Minimum Radius ** (See page 28)	.06 ft/ft	.04 ft/ft	.02 ft/ft
Maximum Grade	9%	12%	18%
Grades for 100' each way from intersection exceeding 5 percent may be reviewed by District Engineer for consideration. Grades less than 0.5 percent should not be used unless reviewed individually by the District Engineer to determine potential maintenance problems.			
K = Rate of Vertical Curvature for Minimum Sight Distance.			
	CREST	20	10
	SAG	20	10
	STOP	9	5
Formula for determination of length of vertical curve required to provide minimum site distance.			
[L = KA]			
L = Length of vertical curve in feet			
K = Rate of vertical curvature in feet per percent of A			
A = Algebraic difference in grades in percent			
Minimum Cul-De-Sac Radius Right of Way			
Curb and Gutter Section	45'	45'	45'
Shoulder Section	50'	50'	50'
Minimum Cul -De-Sac Radius * (See page 28)			
Curb and Gutter Section	37' to F	37' to F	37' to F
Shoulder Section	35'	35'	35'

2. Residential Collector Subdivision Roads include:

- a. Dead End Roads - More than 2500 feet in length
- b. Connecting roads between the local residential subdivision roads and the thoroughfare system
- c. Loop Roads - More than one (1) mile in length
- d. Other roads having a "collector" type function in the thoroughfare system

<u>TERRAIN CLASSIFICATION</u>	<u>LEVEL</u>	<u>ROLLING</u>	<u>MOUNTAINOUS</u>
Terrain Classification Definition			
<u>Level</u> - Natural slope range of 0% to 8%			
<u>Rolling</u> - Natural slope range of 8.1% to 15%			
<u>Mountainous</u> - Natural slope over 15%			
Right of Way Width			
Curb and Gutter Section	50'	50'	50'
Shoulder Section	50'	50'	50'
Pavement Width			
Curb and Gutter Section	34' F-F	34' F-F	34' F-F
Shoulder Section	20'	20'	20'
F-F refers to face to face of standard curb and gutter section. Other types will be reviewed by the Division Engineer with the F-F limits applicable.			
Minimum Shoulder Width			
Shoulder Section	6'	6'	6'
Maximum Cut and Fill Slopes	2:1	2:1	1 1/2:1
Design Speed	35 mph	30 mph	25 mph
Minimum Sight Distance on Vertical Curves	250'	200'	150'
Minimum Centerline Radius	310'	230'	150'
Minimum Superelevation Rate for Minimum Radius ** (See page 28)	.08 ft/ft	.06 ft/ft	.04 ft/ft
Maximum Grade	6%	9%	12%

Grades for 100' each way from intersection exceeding 5 percent (%) may be reviewed by District Engineers for consideration. Grades less than 0.5 percent should not be used unless reviewed individually by the District Engineer to determine potential maintenance problems.

K = Rate of Vertical Curvature for minimum sight distance

CREST	45	30	20
SAG	45	30	20
STOP	20	14	9

Formula for determination of length of vertical curve required to provide minimum sight distance.

$$[L = KA]$$

L = Length of vertical curve in feet

K = Rate of vertical curvature in feet per percent of A

A = Algebraic difference in grades in percent

3. Thoroughfare Plan Roads

For subdivision developments resulting in the construction of a thoroughfare plan route by the developer, the subdivision plan will be forwarded through the District Engineer, to the Traffic Engineering Branch for review by appropriate personnel of the Division of Highways in Raleigh, North Carolina.

4. Industrial Access or Commercial Complex Roads

The minimum construction standards for industrial access road requests or for commercial centers and office complexes will be reviewed individually. The construction standards for pavement design will be in line with expected usage. Final pavement design will be approved by the District Engineer.

*NOTE: On cul-de-sacs, a maximum of two-tenths of a mile in length, 18 feet of pavement (excluding gutter) will be allowed. (See page 45)

Cul-de-sac designs other than the "Bulb" End Design will be subject to the approval of the Division Engineer after review on an individual basis.

**NOTE: The minimum superelevation rates shown for the varying design speeds are for the minimum radii shown. For radii different from these, use the appropriate table from the latest Edition of AASHTO's *Policy on Geometric Design of Highways and Streets* for a desirable design. For a minimum design, the superelevation rate can be calculated from the simplified curve formula:

$$e = \left(\frac{V^2}{15R} \right) - f$$

where

e = superelevation rate in foot per foot

V = design speed in miles per hour

R = Radius of curve in feet

f = side friction factor (see tables *Policy on Geometric Design of Highways and Streets*)

Short cul-de-sacs and dead end streets 1500 feet or less in length may be accepted without superelevation.

Transportation and Highway Laws of North Carolina

§136-102.6. Compliance of subdivision streets with minimum standards of the Board of Transportation required of developers

- (a) The owner of a tract or parcel of land which is subdivided from and after October 1, 1975, into two or more lots, building sites, or other divisions for sale or building development for residential purposes, where such subdivision includes a new street or the changing of an existing street, shall record a map or plat of the subdivision with the Register of Deeds of the county in which the land is located. The map or plat shall be recorded prior to any conveyance of a portion of said land, by reference to said map or plat.
- (b) The right-of-way of any new street or change in an existing street shall be delineated upon the map or plat with particularity and such streets shall be designated to be either public or private. Any street designated on the plat or map as public shall be conclusively presumed to be an offer of dedication to the public of such street.
- (c) The right-of-way and design of streets designated as public shall be in accordance with the minimum right-of-way and construction standards established by the Board of Transportation for acceptance on the State highway system. If a municipal or county subdivision control ordinance is in effect in the area proposed for subdivision, the map or plat required by this section shall not be recorded by the Register of Deeds until after it has received final plat approval by the municipality or county, and until after it has received a certificate of approval by the Division of Highways as herein provided as to those streets regulated in subsection (g). The certificate of approval may be issued by a District Engineer of the Division of Highways of the Department of Transportation.
- (d) The right-of-way and construction plans for such public streets in residential subdivisions, including plans for street drainage, shall be submitted to the Division of Highways for review and approval, prior to the recording of the subdivision plat in the office of the Register of Deeds. The plat or map required by this section shall not be recorded by the Register of Deeds without a certificate of approval by the Division of Highways of the plans for the public street as being in accordance with the minimum standards of the Board of Transportation for acceptance of the subdivision street on the State highway system for maintenance. The certificate of approval shall not be deemed an acceptance of the dedication of such streets on the subdivision plat or map. Final acceptance by the Division of Highways of such public streets and placing them on the State highway system for maintenance shall be conclusive proof that the streets have been constructed according to the minimum standards of the Board of Transportation.
- (e) No person or firm shall place or erect any utility in, over, or upon the existing or proposed right-of-way of any street in a subdivision to which this section applies, except in accordance with the Division of Highway's policies and procedures for accommodating utilities on highway rights-of-way, until the Division of Highways has given written approval of the location of such utilities. Written approval may be in the form of exchange of correspondence until such times as it is requested to add the street or streets to the State system, at which time an encroachment agreement furnished by the Division

§136-102.6 Continued

of Highways must be executed between the owner of the utility and the Division of Highways.

The right of any utility placed or located on a proposed or existing subdivision public street right-of-way shall be subordinate to the street right-of-way, and the utility shall be subject to regulation by the Department of Transportation. Utilities are defined as electric power, telephone, television, telegraph, water, sewage, gas, oil, petroleum products, steam, chemicals, drainage, irrigation, and similar lines. Any utility installed in a subdivision street not in accordance with the Division of Highways, accommodation policy, and without prior approval by the Division of Highways, shall be removed or relocated at no expense to the Division of Highways.

- (f) Prior to entering any agreement or any conveyance with any prospective buyer, the developer and seller shall prepare and sign, and the buyer of the subject real estate shall receive and sign an acknowledgment of receipt of a separate instrument known as the subdivision streets disclosure statement (hereinafter referred to as disclosure statement.) Said disclosure statement shall fully and completely disclose the status (whether public or private) of the street upon which the house or lot fronts. If the street is designated by the developer and seller as a public street, the developer and seller shall certify that the right-of-way and design of the street has been approved by the Division of Highways, and that the street has been or will be constructed by the developer and seller in accordance with the standards for subdivision streets adopted by the Board of Transportation for acceptance on the highway system. If the street is designated by the developer and seller as a private street, the developer and seller shall include in the disclosure statement an explanation of the consequences and responsibility as to maintenance of a private street, and shall fully and accurately disclose the party or parties upon whom responsibility for construction and maintenance of such street or streets shall rest, and shall further disclose that the street or streets will not be constructed to minimum standards, sufficient to allow their inclusion on the State highway system for maintenance. The disclosure statement shall contain a duplicate original which shall be given to the buyer. Written acknowledgment of receipt of the disclosure statement by the buyer shall be conclusive proof of the delivery thereof.
- (g) The provisions of this section shall apply to all subdivisions located outside municipal corporate limits. As to subdivisions inside municipalities, this section shall apply to all proposed streets or changes in existing streets on the State highway system as shown on the comprehensive plan for the future development of the street system made pursuant to G.S. 136-66.2, and in effect at the date of approval of the map or plat.
- (h) The provisions of this section shall not apply to any subdivision that consists only of lots located on Lakes Hickory, Norman, Mountain Island and Wylie which are lakes formed by the Catawba River which lots are leased upon October 1, 1975. No roads in any such subdivision shall be added to the State maintained road system without first having been brought up to standards established by the Board of Transportation for inclusion of roads in the system, without expense to the State. Prior to entering any agreement or any

§136-102.6 Continued

conveyance with any prospective buyer of a lot in any such subdivision, the seller shall prepare and sign, and the buyer shall receive and sign an acknowledgment of receipt of a

statement fully and completely disclosing the status of and the responsibility for construction and maintenance of the road upon which such lot is located.

- (i) The purpose of this section is to insure that new subdivision streets described herein to be dedicated to the public will comply with the State standards for placing subdivision streets on the State highway system for maintenance, or that full and accurate disclosure of the responsibility for construction and maintenance of private streets be made. This section shall be construed and applied in a manner which shall not inhibit the ability of public utilities to satisfy service requirements of subdivisions to which this section applies.
- (j) The Division of Highways and District Engineers of the Division of Highways of the Department of Transportation shall issue a certificate of approval for any subdivision affected by a roadway corridor official map established by the Board of Transportation only if the subdivision conforms to Article 2E of this Chapter or conforms to any variance issued in accordance with that Article.
- (k) A willful violation of any of the provisions of this section shall be a Class I misdemeanor.

NORTH CAROLINA ADMINISTRATIVE CODE
HIGHWAY OBSTRUCTIONS INTERFERING
WITH TRAFFIC MAINTENANCE
19A NCAC 2E.0404

Highway obstructions include driveway headwalls, fences, rural mailboxes, newspaper delivery boxes and other roadside obstructions interfering with traffic or maintenance.

- 1) It shall be unlawful to place any highway obstruction, including a driveway headwall, fence, rural mailbox, newspaper delivery box or other roadside obstruction, so as to interfere with the traffic or maintenance of the roads and highways of the state highway system.
- 2) If the department determines, that any highway obstruction, including a driveway headwall, fence, rural mailbox, newspaper delivery box, its supports or other roadside obstruction, constitutes an unreasonable roadside collision hazard, the highway obstruction shall be removed by the person responsible for placing the obstruction within the right-of-way within 30 days of receipt of a written notice from the department to the person responsible for placing the obstruction within the right-of-way.
- 3) Only mailboxes or newspaper delivery boxes with non-rigid type posts, such as a 4" x 4" wooden or a small diameter metal type, are permitted on road additions made to the state highway system after May 3, 1990. The location within the right of way of an addition to the system of any brick columns, mailboxes or newspaper delivery boxes on rigid stands such as block, stone or any other type determined to be a traffic hazard is prohibited.
- 4) The failure of the person responsible for placing the unlawful obstruction within the right of way, to remove the obstruction within 30 days after written notice by the Department of Transportation shall constitute a misdemeanor. Failure to remove or make safe any mailbox or newspaper delivery its supports or any other obstruction within the specified 30 days of this Rule shall be cause for the Department's Division Engineer to take action to remove the unacceptable mailbox or newspaper delivery box, its supports or other obstruction installation and also bill the responsible party for the expense of removal if appropriate. (See Page 13, No.18)

NORTH CAROLINA DEPARTMENT OF TRANSPORTATION
PETITION FOR ROAD ADDITION
FORM SR-1 REVISED Jan-2010

ROADWAY INFORMATION: (Please Print)

County: _____ Road Name: _____
(Please list additional street names and lengths on the back of this form.)

Subdivision Name: _____ Length (miles): _____

Number of occupied homes having street frontage: _____

Location: _____ miles N S E W of the intersection of Route _____ and Route _____
(Circle one) (SR, NC or US) (SR, NC or US)

We, the undersigned, being property owners and/or developer of _____ in
_____ County, do hereby request the Division of Highways to add the above described
road.

CONTACT PERSON: Name and Address of First Petitioner. (Please Print)

Name: _____ Phone Number: _____

Street Address: _____

Mailing Address: _____

<u>NAME</u>	<u>PROPERTY OWNERS</u> <u>MAILING ADDRESS</u>	<u>TELEPHONE</u>
_____	_____	_____
_____	_____	_____
_____	_____	_____
_____	_____	_____
_____	_____	_____
_____	_____	_____
_____	_____	_____
_____	_____	_____
_____	_____	_____
_____	_____	_____
_____	_____	_____
_____	_____	_____
_____	_____	_____
_____	_____	_____
_____	_____	_____
_____	_____	_____
_____	_____	_____
_____	_____	_____
_____	_____	_____
_____	_____	_____
_____	_____	_____
_____	_____	_____

INSTRUCTIONS FOR COMPLETING PETITION:

1. Complete Information Section
2. Identify Contact Person (This person serves as spokesperson for petitioner(s)).
3. Attach Two (2) copies of recorded subdivision plat or property deeds, which refer to candidate road.
4. Adjoining property owners and/or the developer may submit a petition. Subdivision roads with prior NCDOT review and approval only require the developer's signature.
5. If submitted by the developer, encroachment agreements from all utilities located within the right of way shall be submitted with the petition for Road addition. However, construction plans may not be required at this time.
6. Submit to District Engineer's Office.

Form SR-1

FOR NCDOT USE ONLY: Please check the appropriate block

- Rural Road
 Subdivision established prior to October 1, 1975
 Subdivision established after October 1, 1975

REQUIREMENTS FOR ADDITION

If this road meets the requirements necessary for addition, we agree to grant the Department of Transportation a right-of-way of the necessary width to construct the road to the minimum construction standards of the NCDOT. This right-of-way will extend the entire length of the road that is requested to be added to the state maintained system and will include the necessary areas outside of the right-of-way for cut and fill slopes and drainage. Also, we agree to dedicate additional right-of-way at intersections for sight distance and design purposes and to execute said right-of-way agreement forms that will be submitted to us by representatives of the NCDOT. The right-of-way shall be cleared at no expense to the NCDOT, which includes the removal of utilities, fences, other obstructions, etc.

General Statute 136-102.6 states that any subdivision recorded on or after October 1, 1975, must be built in accordance with NCDOT standards in order to be eligible for addition to the State Road System.

<u>ROAD NAME</u>	<u>HOMES</u>	<u>LENGTH</u>	<u>ROAD NAME</u>	<u>HOMES</u>	<u>LENGTH</u>

VERIFICATION OF COMPLIANCE WITH
ENVIRONMENTAL REGULATIONS

(Check Appropriate Box)

Permits from the N.C. Department of Environment and Natural Resources and the U.S. Army Corps of Engineers are not required for this project. However, all applicable federal regulations have been followed.

The required permits from the Department of Environment and Natural Resources and the U.S. Army Corps of Engineers have been obtained for this project. Copies of permits and Completion Certificates are attached.

All applicable NPDES Stormwater Permit requirements have been met for this project. (The applicant should contact the N.C. Division of Water Quality in Raleigh to determine if a stormwater permit is required)

The project is in compliance with all applicable sedimentation and erosion control laws and regulations.

Project Name: _____

Township: _____

County: _____

Project Engineer: _____

Phone No.: _____

Project Contact: _____

Applicant's Name: _____

P.E. SEAL

Date Submitted : _____

(Reference Page 9, Item 10)

APPLICATION IDENTIFICATION		N.C. DEPARTMENT OF TRANSPORTATION	
Driveway Permit No.	Date of Application	STREET AND DRIVEWAY ACCESS PERMIT APPLICATION	
County:			
Development Name:			
LOCATION OF PROPERTY:			
Route/Road:			
Exact Distance	<input type="checkbox"/> Miles <input type="checkbox"/> Feet	N <input type="checkbox"/> S <input type="checkbox"/> E <input type="checkbox"/> W	
From the Intersection of Route No. _____ and Route No. _____ Toward _____			
Property Will Be Used For:	<input type="checkbox"/> Residential /Subdivision	<input type="checkbox"/> Commercial	<input type="checkbox"/> Educational Facilities
	<input type="checkbox"/> TND	<input type="checkbox"/> Emergency Services	<input type="checkbox"/> Other
Property:	<input type="checkbox"/> is	<input type="checkbox"/> is not	within _____ City Zoning Area.
AGREEMENT			
<ul style="list-style-type: none"> • I, the undersigned property owner, request access and permission to construct driveway(s) or street(s) on public right-of-way at the above location. • I agree to construct and maintain driveway(s) or street entrance(s) in absolute conformance with the current "Policy on Street and Driveway Access to North Carolina Highways" as adopted by the North Carolina Department of Transportation. • I agree that no signs or objects will be placed on or over the public right-of-way other than those approved by NCDOT. • I agree that the driveway(s) or street(s) will be constructed as shown on the attached plans. • I agree that that driveway(s) or street(s) as used in this agreement include any approach tapers, storage lanes or speed change lanes as deemed necessary. • I agree that if any future improvements to the roadway become necessary, the portion of driveway(s) or street(s) located on public right-of-way will be considered the property of the North Carolina Department of Transportation, and I will not be entitled to reimbursement or have any claim for present expenditures for driveway or street construction. • I agree that this permit becomes void if construction of driveway(s) or street(s) is not completed within the time specified by the "Policy on Street and Driveway Access to North Carolina Highways". • I agree to pay a \$50 construction inspection fee. Make checks payable to NCDOT. This fee will be reimbursed if application is denied. • I agree to construct and maintain the driveway(s) or street(s) in a safe manner so as not to interfere with or endanger the public travel. • I agree to provide during and following construction proper signs, signal lights, flaggers and other warning devices for the protection of traffic in conformance with the current "Manual on Uniform Traffic Control Devices for Streets and Highways" and Amendments or Supplements thereto. Information as to the above rules and regulations may be obtained from the District Engineer. • I agree to indemnify and save harmless the North Carolina Department of Transportation from all damages and claims for damage that may arise by reason of this construction. • I agree that the North Carolina Department of Transportation will assume no responsibility for any damages that may be caused to such facilities, within the highway right-of-way limits, in carrying out its construction. • I agree to provide a Performance and Indemnity Bond in the amount specified by the Division of Highways for any construction proposed on the State Highway system. • The granting of this permit is subject to the regulatory powers of the NC Department of Transportation as provided by law and as set forth in the N.C. Policy on Driveways and shall not be construed as a contract access point. • I agree that the entire cost of constructing and maintaining an approved private street or driveway access connection and conditions of this permit will be borne by the property owner, the applicant, and their grantees, successors, and assignees. • I AGREE TO NOTIFY THE DISTRICT ENGINEER WHEN THE PROPOSED WORK BEGINS AND WHEN IT IS COMPLETED. 			
2004-07	NOTE: Submit Four Copies of Application to Local District Engineer, N.C. Department of Transportation 61-03419		TEB 65-04rev.

SIGNATURES OF APPLICANT

PROPERTY OWNER (APPLICANT)		WITNESS	
COMPANY _____ SIGNATURE _____ ADDRESS _____ _____ Phone No. _____	NAME _____ SIGNATURE _____ ADDRESS _____ _____		

AUTHORIZED AGENT		WITNESS	
COMPANY _____ SIGNATURE _____ ADDRESS _____ _____ Phone No. _____	NAME _____ SIGNATURE _____ ADDRESS _____ _____		

APPROVALS

APPLICATION RECEIVED BY DISTRICT ENGINEER

SIGNATURE **DATE**

APPLICATION APPROVED BY LOCAL GOVERNMENTAL AUTHORITY (when required)

SIGNATURE **TITLE** **DATE**

APPLICATION APPROVED BY NCDOT

SIGNATURE **TITLE** **DATE**

INSPECTION BY NCDOT

SIGNATURE **TITLE** **DATE**

COMMENTS:

DRAINAGE DATA

LOCATION		RUNOFF					ROADWAY (C&G ONLY)				PIPE DESIGN						REMARKS		
INLET	NUMBER	INLET DRAINAGE AREA	INLET DISCHARGE	TOTAL DRAINAGE AREA	TOTAL DISCHARGE	FREQUENCY	GUTTER GRADE	PAVEMENT CROSS SLOPE	GUTTER SPREAD	INLET BYPASS	INLET INVERT ELEVATION	OUTLET INVERT ELEVATION	SLOPE	PIPE DIAMETER & TYPE	CAPACITY	HWD	OVERTOPPING ELEVATION		

Any Industry Standard form may be submitted

(Reference Page 8, No. 5)

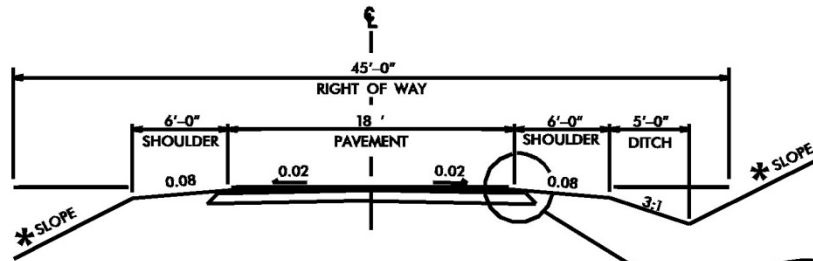

RESIDENTIAL LOCAL ROAD

SHOULDER WIDTH BETWEEN 4' AND 6' SHALL BE APPROVED BY THE DISTRICT ENGINEER CONSIDERING ADJACENT LAND CHARACTERISTICS

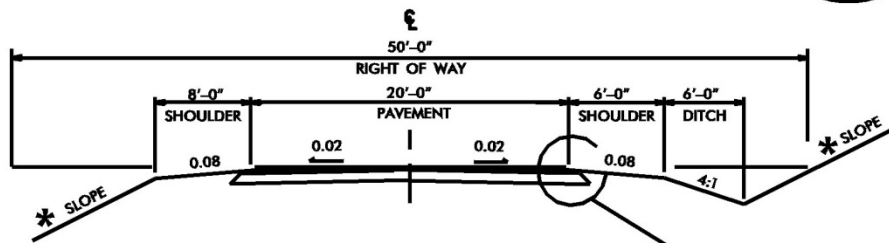

RESIDENTIAL COLLECTOR ROAD

* TERRAIN	MAX. SLOPE
LEVEL	2:1
ROLLING	2:1
MOUNTAINOUS	1- 1/2:1

TYPICAL SHOULDER /CROSS SECTION

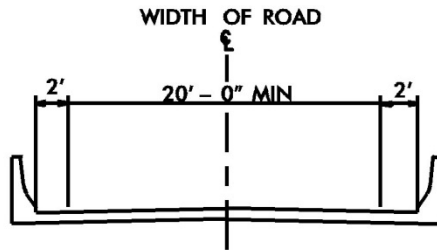

BRIDGE TYPICAL SECTION

FIGURE 1

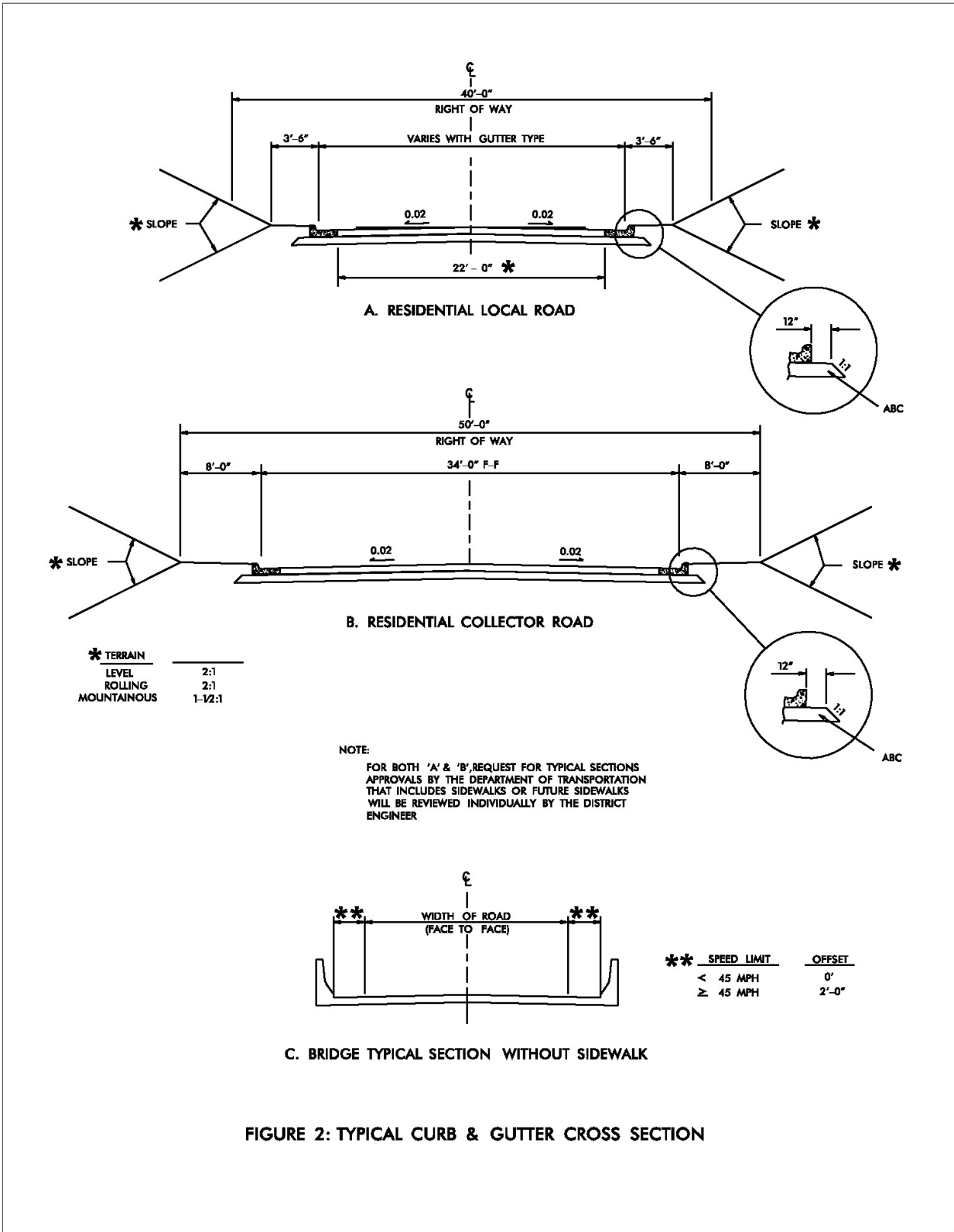
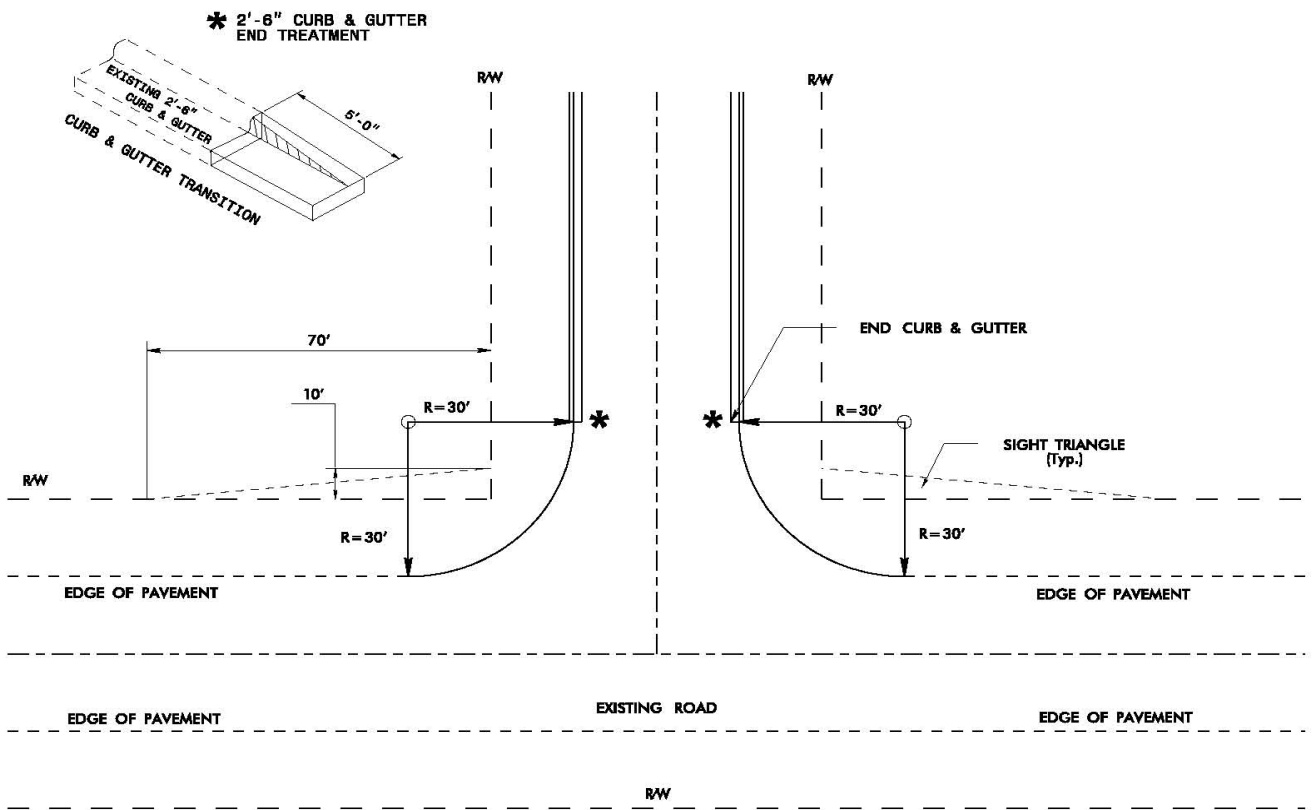

FIGURE 2: TYPICAL CURB & GUTTER CROSS SECTION



NOTE: Drainage easements may be required to accommodate drainage beyond the right-of-way.

FIGURE 3

RECOMMENDED ROAD CONNECTION TO STATE MAINTAINED SYSTEM

NEW RESIDENTIAL LOCAL ROAD OR RESIDENTIAL COLLECTOR ROAD WITH CURB & GUTTER AND EXISTING STATE MAINTAINED ROAD WITH SHOULDER SECTION

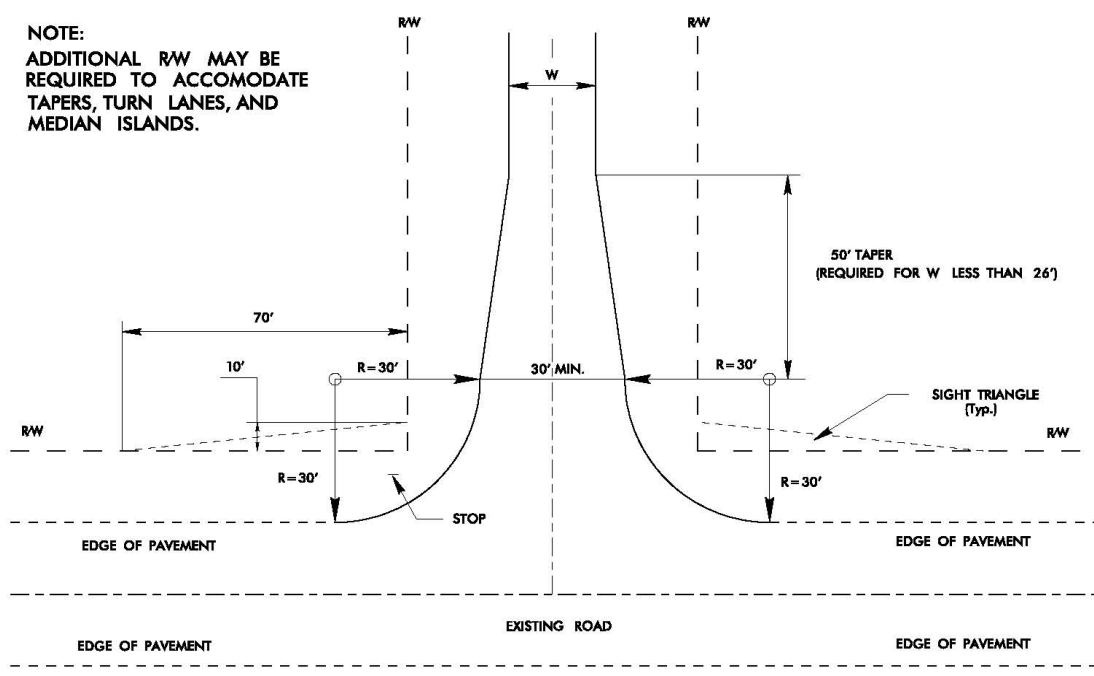

NOTE: Drainage easements may be required to accommodate drainage beyond the right-of-way.

FIGURE 4
RECOMMENDED ROAD CONNECTION
WITHOUT CURB & GUTTER
NEW RESIDENTIAL LOCAL ROAD OR RESIDENTIAL
COLLECTOR ROAD AND EXISTING STATE MAINTAINED
ROAD
STOP CONDITION

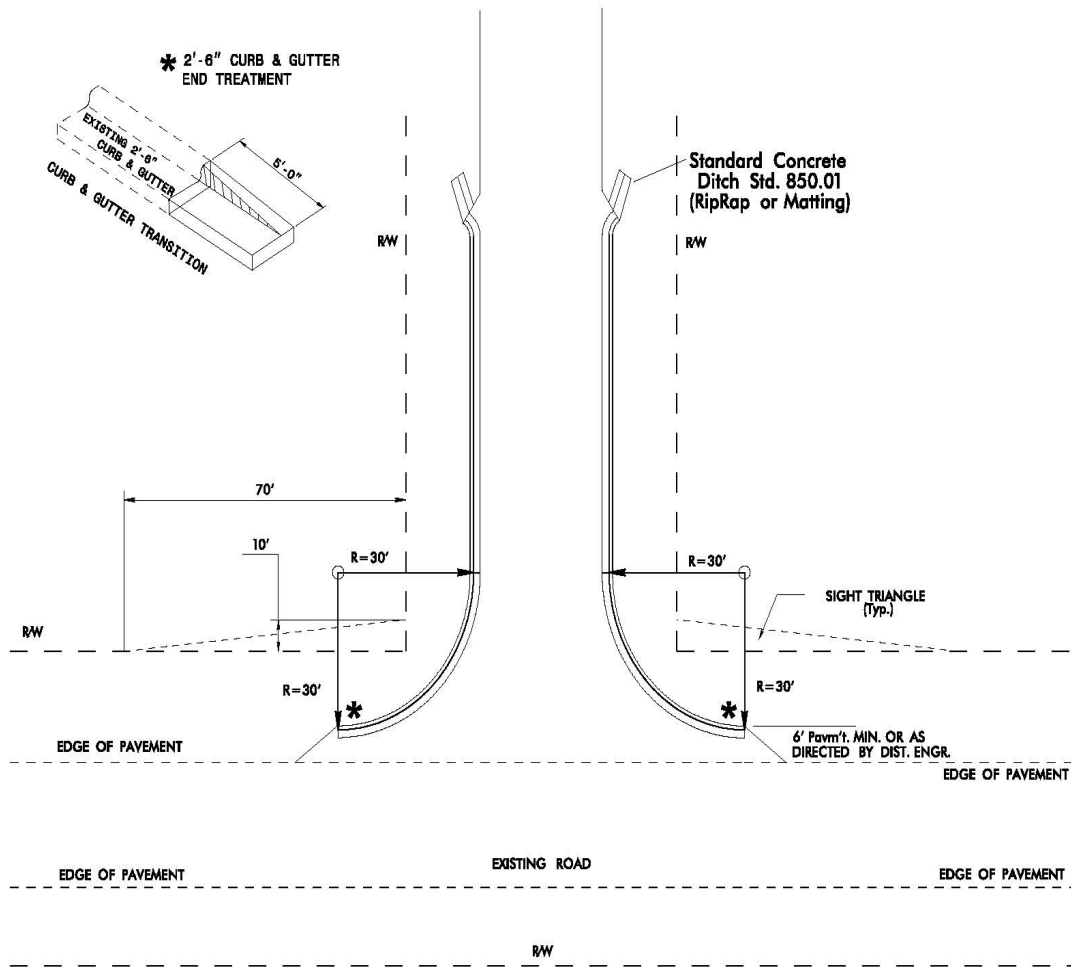

NOTE: Drainage easements may be required to accommodate drainage beyond the right-of-way.

RECOMMENDED ROAD CONNECTION
WITH CURB AND GUTTER

* SEE ISLAND DETAIL IF AN INTERIOR
ISLAND IS TO BE INSTALLED

FIGURE 5

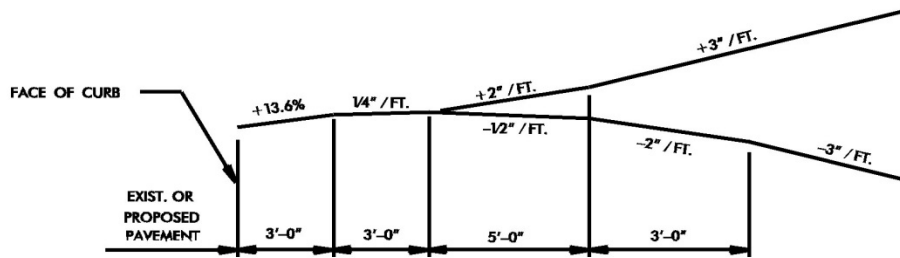

A. CURB & GUTTER SECTION

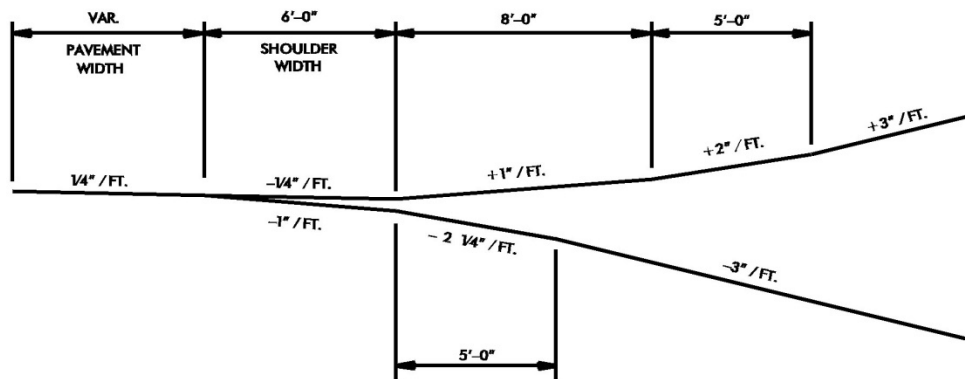

B. SHOULDER SECTION

FIGURE 6

DRIVEWAY TURNOUT GRADES

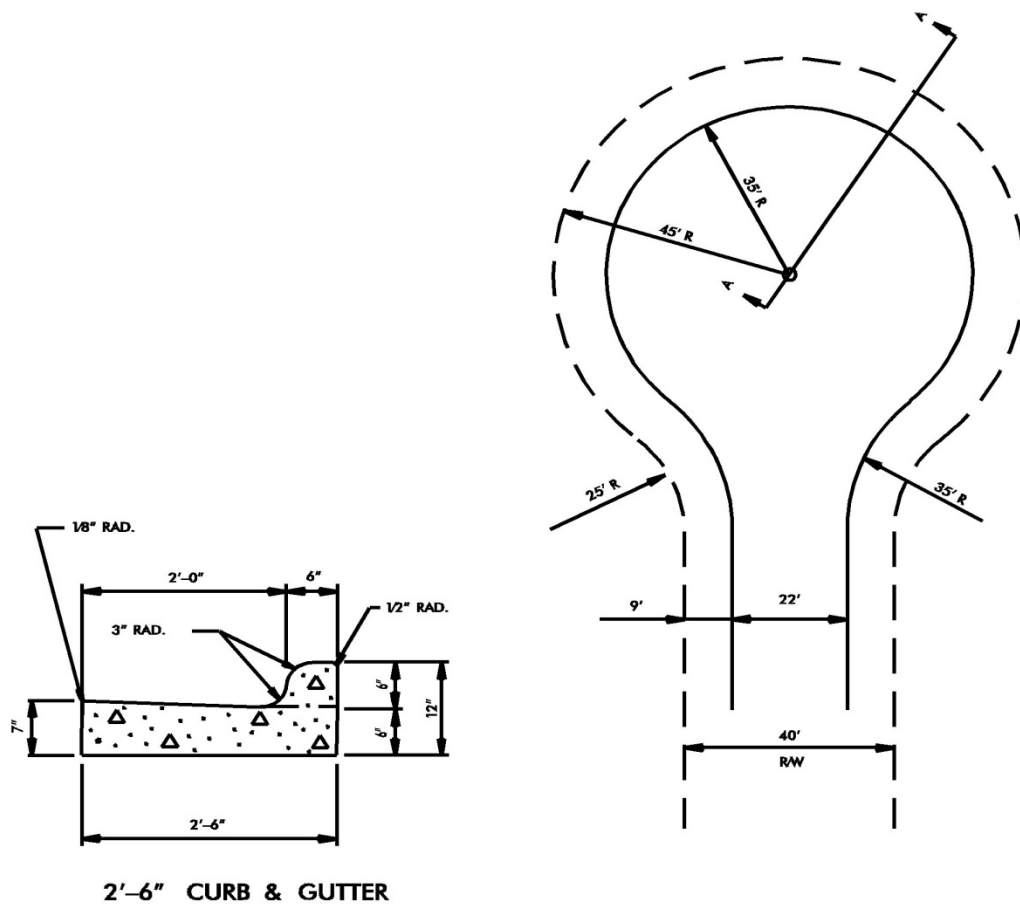

2'-6" CURB & GUTTER

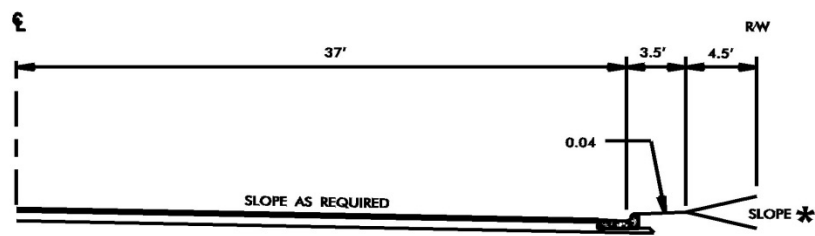

* TERRAIN	MAX. SLOPE
LEVEL	2:1
ROLLING	2:1
MOUNTAINOUS	1-1/2:1

SECTION AA

FIGURE 7
SYMMETRICAL CUL-DE-SAC WITH
CURB & GUTTER

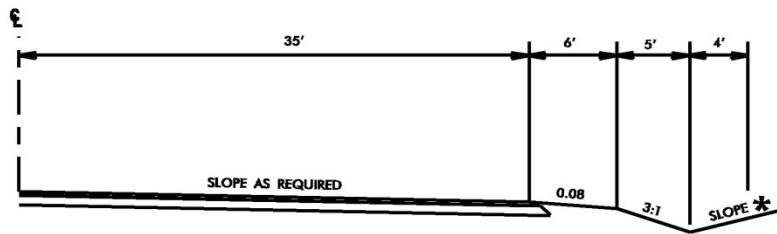
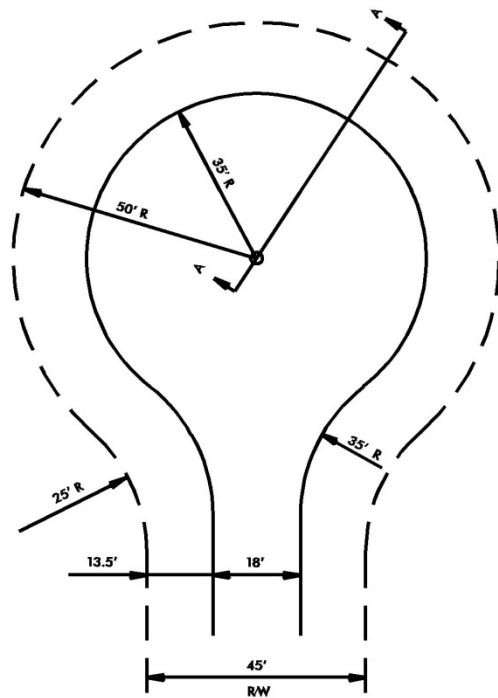

* TERRAIN	MAX. SLOPE
LEVEL	2:1
ROLLING	2:1
MOUNTAINOUS	1-1/2:1

SECTION AA

FIGURE 8

SYMMETRICAL CUL-DE-SAC

NO CURB & GUTTER

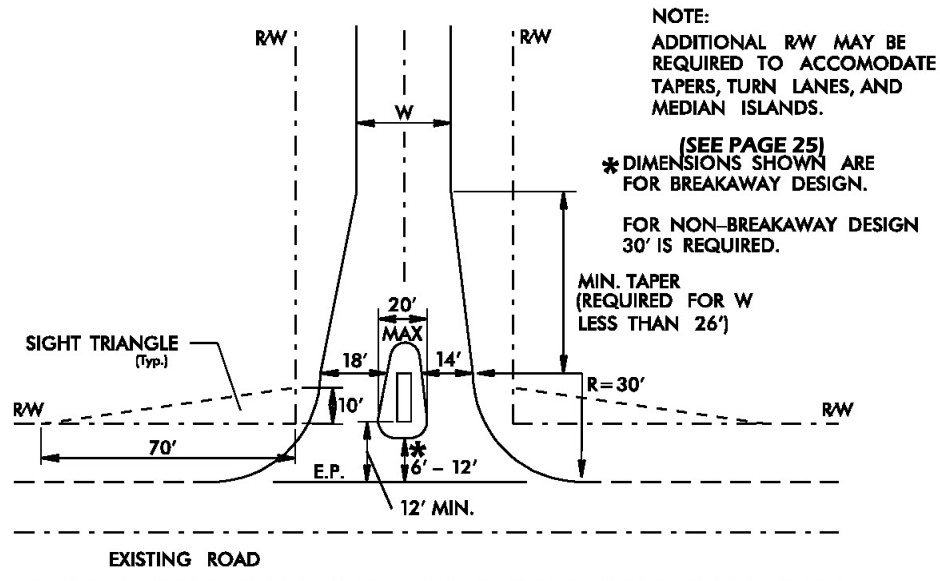

STOP CONDITIOIN
RECOMMENDED ROAD CONNECTION
WITH INTERIOR ISLAND

NOTE: Drainage easements may be required to accomodate drainage beyond the right-of-way.

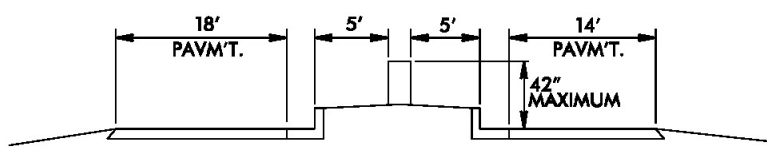

DETAIL SECTION VIEW OF INTERIOR
ISLAND AND MARKER

FIGURE 9

SOIL TYPE BASE COURSE SPECIAL PROVISION:

(1-17-12)

530

SPI 5-04

Perform the work covered by this provision including, but not limited to, furnishing the source of material; building, maintaining, and obliterating haul roads; clearing and grubbing the material source; removal and disposal of overburden; excavation; hauling; spreading materials; mixing; compacting; shaping to conform to the lines, grades, depth, and typical sections shown on the plans; reconditioning; maintaining the base; restoration of the source and haul roads to an acceptable condition; and seeding and mulching the source.

Materials

Soil type base course consists of one or more natural materials proportioned and blended on the road, and will be Type A, B, or C. Use the type specified in the contract. Provide soil type base course free from vegetative matter and lumps or balls of clay meeting the requirements of the table below for the applicable type. Samples will be taken in accordance with this provision.

**ACCEPTANCE CRITERIA FOR
SOIL TYPE BASE COURSE**

Sieve Size	Type A	Type B	Type C
	% Passing	% Passing	% Passing
2"	--	100%	--
1"	100%	70-100%	100%
1/2"	--	55-100%	--
No. 4	--	35-80%	--
No. 10	65-100%	25-65%	65-100%
No. 40	--	15-45%*	--
No. 200	--	5-25%*	--
Material Passing No. 10 Sieve (Soil Mortar)			
No. 40	40-75%	--	40-95%
No. 200	12-35%	--	12-35%
Material Passing No. 40 Sieve			
L. L.	0-25	0-25	0-25
P. I.	0-6	0-6	0-6

* The fraction passing the No. 200 sieve shall be less than 2/3 the fraction passing the No. 40 sieve.

Construction Methods

Prepare the subgrade in accordance with Section 500 of the *2018 Standard Specifications*. Clear and grub the surface of the material sources and thoroughly clean it of all unsuitable material before beginning excavation. Dispose of material resulting from clearing and grubbing in accordance with Article 200-6 of the *2018 Standard Specifications*. Remove and dispose of overburden in accordance with Section 802 of the *2018 Standard Specifications*.

Where payment is to be made by measuring the material in its original position, notify the Engineer sufficiently in advance of beginning excavation of this material in order that the area may be staked and cross sectioned by the Engineer. No payment will be allowed for any material excavated prior to cross sections being taken. Excavate the material to the lines and slopes as staked by the Engineer and perform the excavation in an orderly manner to facilitate measurement at any time.

Where payment is to be made by truck measurement, furnish trucks with bodies suitable for accurate measurement. Load trucks uniformly and in such a manner as to prevent spillage.

Where it is necessary to haul material over existing roads or streets, the requirements of Article 105-15 of the *2018 Standard Specifications* will apply. Use all necessary precautions to prevent damage to the existing structures or pavement. Conduct hauling operations in such a manner as to not interfere with the normal flow of traffic and keep the traffic lanes free from spillage at all times.

Department Furnished Sources

Where the Department furnishes material sources, the location of such sources will be as designated on the plans. The Department will furnish the necessary haul road right of way at locations designated by the Engineer. Build, maintain, and when directed, obliterate all haul roads required at no cost to the Department. Where the haul road is to be reclaimed for cultivation, plow or scarify the area to a minimum depth of 8 inches.

Remove overburden prior to the excavation of the base material when indicated by the plans. Where it is necessary to drain the material source, perform this work in accordance with Section 240 of the *2018 Standard Specifications*.

Leave the material source in a neat and presentable condition after use. Smooth, round, and construct all slopes not steeper than 2:1. Plow or scarify to a minimum depth of 8 inches, disc harrow, and construct terraces where the source is to be reclaimed for cultivation. Seed and mulch the sources in accordance with Sections 1620, 1660, or 1661 of the *2018 Standard Specifications*.

Follow the requirements of Subarticle 230-4(C) of the *2018 Standard Specifications* when electing to substitute material sources for those provided by the Department.

Contractor Furnished Sources

Approval of material sources furnished by the Contractor is subject to the requirements of Subarticle 230-4(C) of the *2018 Standard Specifications*.

Placing Material

Deposit the material on the subgrade in such a manner that when all layers are spread, mixed, and compacted, the required depth of base material will be obtained. Where more than one type of material is to be used, spread each uniformly over the subgrade prior to placing the next material.

Mixing and Compacting

Immediately after placing and spreading the base material, begin mixing operations. Perform the mixing in a manner which will produce a thoroughly and uniformly mixed base course.

Compact the base uniformly throughout the depth and width of the base. Where the base is thicker than 8", spread the base and compact it in 2 layers approximately equal in thickness.

Compact the base to a density equal to at least 100% of that obtained by compacting a sample of the material in accordance with AASHTO T 99 as modified by the Department. Copies of these modified testing procedures are available upon request from the Materials and Tests Unit.

Compact the base material at a moisture content which is approximately that required to produce the maximum density indicated by the above method. Dry or add moisture to the material when required to provide a uniformly compacted and acceptable base.

Final Shaping

Shape the base to conform to the lines, grades, and typical sections shown on the plans. Take care to prevent the formation of slippage planes in the surface. Thoroughly dry, remix or remove and replace all soft or unstable areas.

Sampling, Testing, and Acceptance

Where the depth of the base is such that the placement of more than one layer is required for proper mixing and compacting, sample, test and have approved each layer of material prior to placing additional base material thereon.

Samples will be taken from the road immediately after the base material has been spread, mixed, and shaped to a true cross section. Sampling and testing for acceptance will be as hereinafter provided.

Use a sampling unit consisting of 500 linear feet when the roadway base is placed in widths 27 feet or less. Use a sampling unit consisting of 1,000 square yards when the base is placed in widths over 27 feet. As an exception to the above, when the base course is constructed utilizing materials in the existing subgrade the sampling units will be reduced to one half the size indicated above. Use a sampling unit consisting of 1,000 linear feet when placing base on a shoulder or widening of 12 feet or less.

One sample will be taken from a location selected by the Engineer in each unit. The sample will be taken by cutting 3 cores for the full depth of the base course, one on the center line and one approximately 3 feet from each edge, and combining the material as one sample representing the material in that unit.

If the sample tested fails to meet specification requirements, obtain 2 check samples, one on each side of the original sample at 50 feet spacing. The unit will be rejected unless both of these samples meet specification requirements.

Where a unit is rejected, no further samples will be taken from that unit until the material is either corrected by the addition and mixing of suitable material or the rejected material is removed and replaced.

Where the material source is furnished by the Contractor and the Engineer permits the Contractor to correct a rejected unit by the addition and mixing of corrective material, perform all work necessary due to the addition of the corrective material at no cost to the Department.

Where the material source is furnished by the Contractor and the rejected unit is in a final layer of base, furnish and incorporate any material added to correct gradation at no cost to the Department. Resampling of a corrected or replaced unit will be performed in the same manner as original sampling.

Tolerances

After final shaping and compacting of the base, the Engineer will check the surface of the base for conformance with the grade and typical section and will determine the base thickness.

Construct the base with a thickness that is within a tolerance of plus or minus 1/2 inch of the base thickness required by the plans. Construct the base such that the maximum differential between the established grade and the base within any 100-foot section is 1/2 inch.

Reconditioning

Where sampling and testing indicate that additional material shall be added to the base to produce the required quality, add the required material, remix, recompact, and reshape the base to the required lines, grades, and typical sections.

Where the Contractor furnishes the material source, perform the work of reconditioning at no cost to the Department.

Maintenance

Where the base material is placed in a trench section, provide adequate drainage through the shoulders to protect the subgrade and base until such time as shoulders are completed.

Maintain the surface of the base by machining, watering, and rolling or dragging when necessary to prevent damage to the base by weather or traffic.

Within 24 hours of completion of the base, prime the base slopes where required or, where prime is not required, place sufficient shoulder material against the edges of the completed base to protect the base.

Where the base or subgrade is damaged due to negligence on the part of the Contractor, repair the damaged area; reshape the base to the required lines, grades, and typical sections; and recompact the base to the required density at no cost to the Department.

Measurement and Payment

Soil Type Base Course, Type ____ will be measured and paid at the contract unit price per cubic yard or ton for the actual number of cubic yards or tons of base course material that has been incorporated into the completed and accepted work. However, no measurement will be made of any additional material which the Engineer has permitted the Contractor to incorporate into a final base layer in the work of reconditioning where the Contractor has furnished the material source.

Measurement of the base course material will be made in accordance with one of the following methods:

(A) When the material is to be measured in its original position, measurement will be made by cross sections and computations will be made by the average end area method. No measurement will be made of any material excavated prior to cross sections being taken.

(B) When the material is to be measured in trucks, the level to which each truck is to be loaded will be measured by the Engineer and each truck shall be suitably marked to indicate the loaded level. Each truck shall bear a suitable mark or number for identification. Load each truck to at least its measured load level when it arrives at the point of delivery. The recorded quantity of material will be adjusted by making a 25 percent deduction to allow for shrinkage, and the adjusted quantity will be the quantity to be paid for.

(C) Where the contract calls for the material to be paid for by the ton, the material will be measured by being weighed in trucks on certified platform scales or other certified weighing devices. No deduction will be made for any moisture contained in the material at the time of weighing.

When material sources are furnished by the Department and the Engineer directs the incorporation of additional material into a rejected sampling unit, the work of reconditioning as provided in the “Reconditioning” section of this provision will be measured as provided below:

When the Contractor furnishes material sources, no measurement of reconditioning will be made.

The quantity of reconditioning to be paid at the contract unit price per 1,000 square yards for *Reconditioning, Soil Type Base Course* will be the actual number of units of 1,000 square yards of base course over which the work of reconditioning has been acceptably performed. The length will be the actual length measured along the centerline of the surface of the base. The width will be the width required by the plans or as directed by the Engineer measured across the top surface of the base.

Where the material source has been furnished by the Department, payment for clearing and grubbing the source will be made as provided in Article 200-8 of the *2018 Standard Specifications*, payment for removal and disposal of overburden will be made as provided for unclassified excavation in Article 225-7 of the *2018 Standard Specifications*, payment for draining the source will be made as provided in Article 240-4 of the *2018 Standard Specifications*, and payment for seeding and mulching the source when required will be made as provided in Article 1660-8 of the *2018 Standard Specifications*.

Where the material source has been furnished by the Contractor, no separate payment will be made for clearing or grubbing, removal and disposal of overburden, draining the source, or seeding the mulching as such work will be considered as incidental to the work covered by this section.

Payment will be made under:

Pay Item

Soil Type Base Course, Type ____
 Soil Type Base Course, Type ____
 Reconditioning, Soil Type Base Course

Pay Unit

Cubic Yard
 Ton
 1,000 Square Yards

USEFUL WEB LINKS

Link	Description	Use
https://connect.ncdot.gov/municipalities/Utilities/Pages/UtilitiesManuals.aspx	NCDOT Utility Manuals	
https://connect.ncdot.gov/resources/hydro/Pages/Guidelines-Drainage-Studies.aspx	NCDOT Hydraulic Unit	Access Drainage Manual
https://connect.ncdot.gov/resources/safety/Tepl/TEPPL%20All%20Documents%20Library/MN-45.pdf	Guide for Erecting Mailboxes on Highways	
https://connect.ncdot.gov/projects/Roadway/RoadwayDesignAdministrativeDocuments/Policy%20on%20Street%20and%20Driveway%20Access.pdf	Policy on Street & Driveway Access	Access Driveway Manual
https://connect.ncdot.gov/resources/Structures/Pages/Structure-Standards.aspx	Standard Drawing Library	NCDOT Standard Drawings
https://connect.ncdot.gov/resources/roadside/AestheticEngineeringDocuments/PlantingGuidelines.pdf	Guidelines for Planting within Highway Right-of-Way	
https://connect.ncdot.gov/resources/safety/Tepl/TEPPL%20All%20Documents%20Library/T11_GTC_SMR.pdf	Guidance --Traffic Calming on State-Maintained Roadways	Traffic Calming Devices
https://connect.ncdot.gov/resources/safety/Tepl/TEPPL%20All%20Documents%20Library/M01_CBU.pdf	Policy for Placement of Mail Cluster Box Units (CBU) on Maintained Subdivision Streets	Mail Cluster Box Units (CBUs)

**UPDATES TO JANUARY 2000 SUBDIVISION MANUAL
EFFECTIVE JANUARY 2010**

(Note: Page references are Jan 2000 Version)

	Description
1.	The date has been changed from January 1, 2000 to January 1, 2010.
2.	Title Page updated with names of Secretary, State Highway Administrator and Chief Engineer.
3.	Table of Contents updated.
4.	District Office locations and phone numbers displayed; weblink available on Page 8.
5.	Page 8 , Application Requirements: End of first paragraph – Added “of this document” following See Page 31.
6.	Page 8 . #4, changed pages to 42 and 43.
7.	Page 8 , Application Requirements, # 6: Change to “Two copies.....” instead of four.
8.	Page 9 , On new subdivision roads lot lines should not extend into the right-of-way. <i>See North Carolina Transportation and Highway Laws</i> , chapter 136, article 7, section 136-102.6 for additional information on right-of-way width and lot lines. (See page 31 of this document for statute).
9.	Page 9 , When property is subdivided along existing state maintained roads the lot lines may extend beyond into the right of way subject to the property owners discretion.
10.	Page 9 , Application Requirements, # 11: The following clarification has been added. “Encroachment agreements (utility & non-utility) are required.....”
11.	Page 10 . Second paragraph... Subdivision roads shall be designated public or private. Public designations shall be designed and constructed...
12.	Page 10 . Second paragraph... as required under General Statute 136-102.6 and are eligible to be added to the State system of roads.
13.	Page 10 . Second paragraph.... Private roads are not eligible to be added to the state system of roads and...
14.	Page 10 , Subdivision Roads, # 1, has been reworded to conform to # 2. “Residential local subdivision road” instead of “Local residential subdivision road,” and is updated throughout the document.

**UPDATES TO JANUARY 2000 SUBDIVISION MANUAL
EFFECTIVE JANUARY 2010**

(Note: Page references are Jan 2000 Version)

	Description
15.	Page 11 , Subdivision Roads, Requirements for Addition...to the System, # 3: Following phrase added, “including structural stormwater control (SSC) devices. (See Page 16 of this document)”
16.	Page 11 . #4 Existing and/or relocated utilities
17.	Page 11 . #4 2nd sentence, Added “should” utility adjustments...”be required, they” shall be made...
18.	Page 12 , Subdivision Roads, Requirements, continuation of # 4, last sentence. Added “of this document” following See page 31.
19.	Page 13 , Subdivision Roads, Requirements, # 13, added this statement: “All drainage structures shall be of sufficient length to accommodate appropriate roadway side slopes, as defined in the minimum construction standards in this manual, with standard height headwalls. Extended height headwalls intended to reduce drainage structure length or to reduce right of way requirements are not acceptable without prior approval of the Division Engineer.”
20.	Page 13 , Subdivision Roads, Requirements, # 15, added “...if maintenance responsibilities by the NCDOT are not increased beyond normal maintenance in applying the construction standards of this document.
21.	Page 13 , #18 Roads being considered for addition must be clear of highway obstructions as defined in NCAC 2E.0404. (See page 34).
22.	Page 14 , Utility Requirements, # 2.e.: added this phrase “except fiber optic.”
23.	Page 14 , Utility Requirements, # 2.f. added.
24.	Page 14 , Utility Requirements, # 4: Changed “Design Services Unit” to “Field Operations Support.”
25.	Page 16 , Minimum Design and Construction Criteria, Section A, second paragraph, first sentence, added the phrase “and rights of way” may be maintained.....
26.	Page 16 , Minimum Design and Construction Criteria, Section A, # 5, added the following: “Note: Use of hydraulic design forms found in <i>Guidelines for Drainage studies and Hydraulic Design</i> will expedite the design review process.”

**UPDATES TO JANUARY 2000 SUBDIVISION MANUAL
EFFECTIVE JANUARY 2010**

(Note: Page references are Jan 2000 Version)

	Description
27.	Page 16. Item A, 5: Provided website for contact information
28.	Page 16. Last paragraph Structural stormwater controls Retention/detention basin shall be located outside the right of way
29.	Page 17. First paragraph and Structural control devices shall be shown on plans where possible.
30.	Page 17. Second paragraph basins stormwater control devices (see Page 17 for Structural Stormwater Controls).
31.	Page 17, Minimum Design and Construction Criteria, Section A, added following sentences at end. "Project Materials shall meet NCDOT Standards. Types of approved material shall be considered with materials listed in " <i>Guidelines for Drainage Studies and Hydraulic Design</i> "."
32.	Page 17, Minimum Design and Construction Criteria, Section A, added new item: Structural Stormwater Controls (new section)
33.	Page 18, Structures (Bridges, Culverts, Dams and Retaining Walls), Bridges, # 1. Added the following sentences: "Bridge submittals shall include alternate structures considered and reasonable justification for selection of bridge structure and length. Generally, avoidance of individual environmental permits would not be considered reasonable justification for use of excessive hydraulic structures or bridge lengths. Deck drains discharging into open water should be avoided."
34.	Page 18, #2 - Clarification of change from HS-25 to HL-93.
35.	Page 18. #3, 2nd sentence.same as the face to face curb to curb approach...
36.	Page 19. #4, b. For superstructures - pre-stressed concrete, reinforced concrete deck slab structural steel I-beams with reinforced concrete deck or corrugated metal deck with asphaltic wearing surface.
37.	Page 19, Structures (Bridges, Culverts, Dams and Retaining Walls), Bridges, #5, changed "where required" to "in accordance with <i>North Carolina Roadway Standard Drawings</i> ."
38.	Page 19, Structures (Bridges, Culverts, Dams and Retaining Walls), Bridges, #6, added "and <i>North Carolina Roadway Standard Drawings</i> ."

**UPDATES TO JANUARY 2000 SUBDIVISION MANUAL
EFFECTIVE JANUARY 2010**

(Note: Page references are Jan 2000 Version)

	Description
39.	Page 19 , Structures (Bridges, Culverts, Dams and Retaining Walls): added new section "Culverts".
40.	Page 19-20, #3 Headwalls are generally used on the inlet end of culverts 36-inch and larger. Maximum height of headwalls shall be one foot above pipe structure.
41.	Page 20 , Structures (Bridges, Culverts, Dams, and Retaining Walls), Roadway Dams, # 1, changed to read: "In those cases, where no other feasible alternatives exist may be considered , the utilization of a dam for a roadway may be favorably considered."
42.	Page 21 , Structures (Bridges, Culverts, Dams, and Retaining Walls), Roadway Dams, # 2.d. The phrase "and installed in accordance with <i>North Carolina Roadway Standard Drawings</i> " has been added to the first sentence.
43.	Page 22 , Structures (Bridges, Culverts, Dams, and Retaining Walls), Retaining Walls: This is a new section.
44.	Page 22 , Minimum Design and Construction Criteria, Section C. Curb and Gutter and Sidewalk: # C.1. Following sentence has been added: "Any other types of curb and gutter shall be subject to the approval of the District Engineer."
45.	Page 22 . Item C-#2 Curb inlet spacing and storm system design shall be consistent with criteria found in <i>NCDOT - Guidelines for Drainage Studies and Hydraulic Design</i> . https://connect.ncdot.gov/resources/hydro/Pages/Guidelines-Drainage-Studies.aspx
46.	Page 22 , Item C, #3 NCDOT will allow sidewalks by encroachment and will not accept responsibility for maintenance. Maintenance responsibility of sidewalks shall be noted on plat.
47.	Page 22-23 , Minimum Design and Construction Criteria, Curb and Gutter and Sidewalk: # 4 through 9 are new.
48.	Page 23 , Minimum Design and Construction Criteria, Wheel Chair Ramps, Second paragraph. The standard drawing is specified: (North Carolina Roadway Standard Drawings No. 848.05 and 848.06)

**UPDATES TO JANUARY 2000 SUBDIVISION MANUAL
EFFECTIVE JANUARY 2010**

(Note: Page references are Jan 2000 Version)

	Description
49.	Page 23, E. Pavement Design - Reword from: “The District Engineer may require a subgrade soil test to determine the soil classification type. Heavier pavement designs may be required based on traffic, truck volumes, etc. and prime coat may be required on ABC.” TO: “The District Engineer may require a subgrade soil test to determine the soil classification type and heavier pavement designs than the minimum designs depending on route classification (local/collector) and traffic loading impacts of planned subdivision phases. A prime coat may be required on ABC.”
50.	Page 25, Minimum Design and Construction Criteria, Item G, Guardrail: Added new first paragraph: “Guardrail may be required at locations meeting guardrail warrants in accordance with NCDOT Design Standards.
51.	Page 25, Minimum Design and Construction Criteria, Item G, Guardrail: Added second paragraph: “Warrant for guardrail may also warrant shoulder berm gutter.”
52.	Page 26. Item H, #1.are acceptable where no other alternatives exist. under extreme conditions.
53.	Page 26. Item H, #3 All internal intersections shall have minimum 30’ radii. Radii less than 30’ must be approved by the District Engineer.
54.	Page 26, Minimum Design and Construction Criteria, Item H, Road Intersections: #4 has been changed to read: “Non-standard design configurations will be reviewed on a case by case basis and must have approval of the District Engineer prior to formal addition to the state system.”
55.	Page 26. Item I. Islands or Short Medians at Subdivision Entrances, #1: The District Engineer may allow the island or median sections under an encroachment permit after review on an individual basis and noted on plans (or encroachment agreement). This shall include all plantings.
56.	Page 26, Minimum Design and Construction Criteria, Item I, Islands or Short Medians at Subdivision Entrances, #4: Sentence added: “Maximum width of island shall be 20 feet.”
57.	Page 27, Minimum Design and Construction Criteria, Item J, Subdivision Name Markers, #5: “recovery area is desirable” has been changed to “a 30-foot set back from edge of pavement of the existing state maintained road is required.”
58.	Page 28, Minimum Design and Construction Criteria, Terrain Classification: Changed “Hilly” to “Mountainous”

**UPDATES TO JANUARY 2000 SUBDIVISION MANUAL
EFFECTIVE JANUARY 2010**

(Note: Page references are Jan 2000 Version)

	Description
59.	Page 28 , Minimum Design and Construction Criteria, Terrain Classification: Changed “Cross” slope to “Natural” slope
60.	Page 28 , Minimum Design and Construction Criteria, Terrain Classification, Right of Way Width: Changed Level from 45’ to 50’; changed Rolling from 45’ to 50’.
61.	Page 28 , Minimum Design and Construction Criteria, Terrain Classification, Pavement Width: Changed “G-G” to “F-F” in all references under this section.
62.	Page 28 . Minimum Cul-De-Sac Radius....curb and gutter section....37’ to F (not G)
63.	Page 29 , Minimum Design and Construction Criteria, #2. Residential Collector Roads, Terrain Classification. Changed “Hilly” to “Mountainous.”
64.	Page 29 , Minimum Design and Construction Criteria, #2. Residential Collector Roads, Terrain Classification, Pavement Width: Changed “G-G” to “F-F” wherever it appears.
65.	Page 30 , Minimum Design and Construction Criteria, # 4. “commercial centers and apartment complexes” changed to “commercial centers and office complexes.”
66.	Page 30 , Minimum Design and Construction Criteria, # 4. *NOTE: Second paragraph, last sentence deleted. (“See Page ## for several examples of minor residential cul-de-sac designs.)
67.	Page 30 . In **NOTE, 1994 2004 Edition of AASHTO’s Policy....formula legend...f = side...(See page 143 147 of the 1994 2004 Policy)
68.	Page 34 , North Carolina Administrative Code. Highway Obstructions Interfering with Traffic Maintenance. 19A NCAC 2E.0404. This item added at this location.
69.	Page 41 , Revised Figure 1 Standard Drawings for Shoulder Section
70.	Page 42 , Revised Figure 2 Standard Drawings for Curb and Gutter Section
71.	Page 43 , Revised Figure 3 for Road Connection to State Maintained System (Removed “Permanent” from Drainage Easements)
72.	Page 44 , Revised Figure 4 for Road Connection to State Maintained System (Removed “Permanent” from Drainage Easements)

**UPDATES TO JANUARY 2000 SUBDIVISION MANUAL
EFFECTIVE JANUARY 2010**

(Note: Page references are Jan 2000 Version)

	Description
73.	Page 45 , Revised Figure 5 Line types, (Removed “Permanent” from Drainage Easement)
74.	Page 48 , Made corrections to 1/8” RAD and ½” RAD on Curb and Gutter Drawing
75.	Page 46 , Removed 2’-0” Valley Curb Gutter Drawing (See Page 22 C.1 for Committee recommendation)
76.	Deleted Figures 9, 10, 11
77.	Page 49 , Added “20’ max” dimension to match Driveway Manual and “*Dimensions Shown are for Breakaway Design”

**REVISIONS TO JANUARY 2010 SUBDIVISION MANUAL
EFFECTIVE MAY 2016**

(Note: Page references are Jan 2010 Version)

	Description
1.	May 2016 revision date added to Title Page
2.	Title Page updated with names & contact info of Secretary, previous title of State Highway Administrator changed to Chief Engineer with name & contact info updated, previous title of Chief Engineer changed to Deputy Chief Engineer with name & contact info updated
3.	Updated Table of Contents
4.	District Office locations and phone numbers updated.
5.	Page 22 , Section E, Pavement Design – added note for additional information on the design and construction of Concrete Pavement for Local Roads and Streets; provided web link: https://connect.ncdot.gov/resources/Asset-Management/Pages/subdivisions.aspx List documents available via the link, i.e. Specifications, Design Guidance, Detail Drawings, and Standard Notes
6.	Page 23 , Group I - added note for additional information on the design and construction of Concrete Pavement for Local Roads and Streets; provided web link: https://connect.ncdot.gov/resources/Asset-Management/Pages/subdivisions.aspx
7.	Page 23 , Group II - added note for additional information on the design and construction of Concrete Pavement for Local Roads and Streets; provided web link: https://connect.ncdot.gov/resources/Asset-Management/Pages/subdivisions.aspx
8.	Appendix A-2 , update web links

**REVISIONS TO JANUARY 2010 SUBDIVISION MANUAL
EFFECTIVE July 2020**

(Note: Page references are Jan 2010 Version)

	Description
1.	July 2020 revision date added to Title Page
2.	Title Page updated with names & contact info of Secretary, Chief Engineer and Deputy Chief Engineer
3.	Updated Table of Contents
4.	District Office locations and phone numbers updated.
5.	Page 10 , updated bullet #1 subtitle to “Residential Local Subdivision Road”; updated bullet #2 subtitle to “Residential Collector Subdivision Road”
6.	Page 27 , Added “Subdivision” to subtitle
7.	Page 28 , Changed “See Pages 45 and 46” to “See Page 45”
8.	Update all web links throughout document
9.	Appendix A-2 , Revise and update web links

**REVISIONS TO JANUARY 2010 SUBDIVISION MANUAL
EFFECTIVE December 2020**

(Note: Page references are Jan 2010 Version)

	Description
1.	December 2020 revision date added to Title Page
2.	Title Page updated with names & contact info of Chief Engineer
3.	Updated Table of Contents
4.	Page 23 and 24 , removed all references to SF9.5A; replaced B25.0B with B25.0C
5.	Added new Appendix A, Soil Type Base Course Special Provision
6.	Re-ordered the remaining Appendices